

RNA 6919 SKF

Needle roller bearings

TYPE: Roller bearings, Needle, Double row, With machined rings with flanges, without an inner ring, Metric

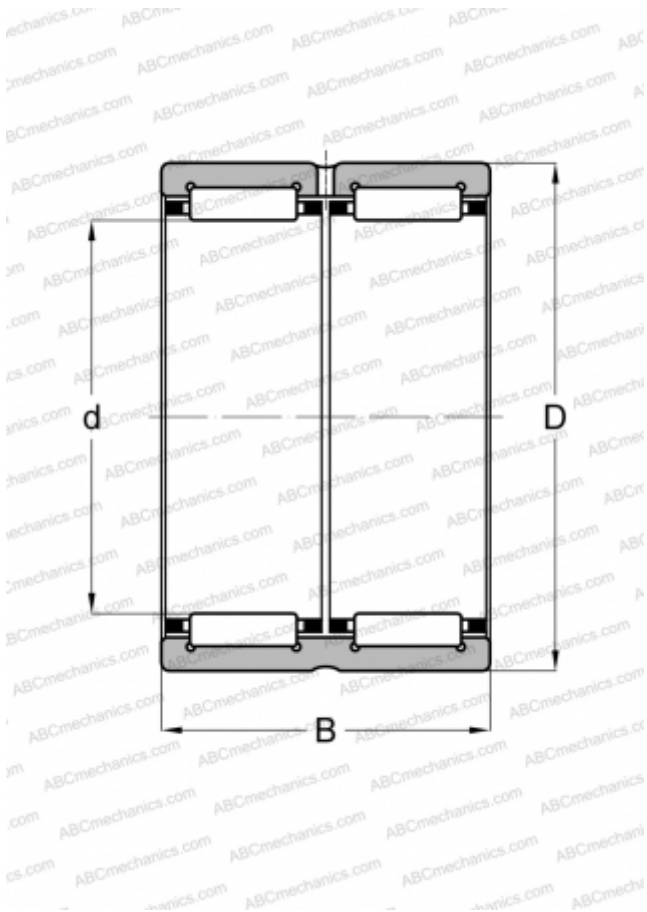

Technical specification

DIMENSIONS, MM

d	110,000
D	130,000
B	63,000

WEIGHT, KG

1,450

MANUFACTURER

[SKF](#)

INTERCHANGE

ABC	RNA 6919
IKO	RNA 6919
FAG	RNA 6919
INA	RNA 6919-ZW
TORRINGTON	RNA 6919

CALCULATION DATA

Basic dynamic load rating, C	172,000 kN
Basic static load rating, Co	465,000 kN
Fatigue load limit, Pu	56,000 kN
Reference speed	3600 r/min
Limiting speed	4000 r/min

REPLACES

RNNA 6919

ASSOCIATED PRODUCTS

CR 110x130x12 HMS5 RG