

RNA 6907 UU IKO

Needle roller bearings

TYPE: Roller bearings, Needle, Double row, Lip seals on both side, metric, With machined rings with flanges, without an inner ring

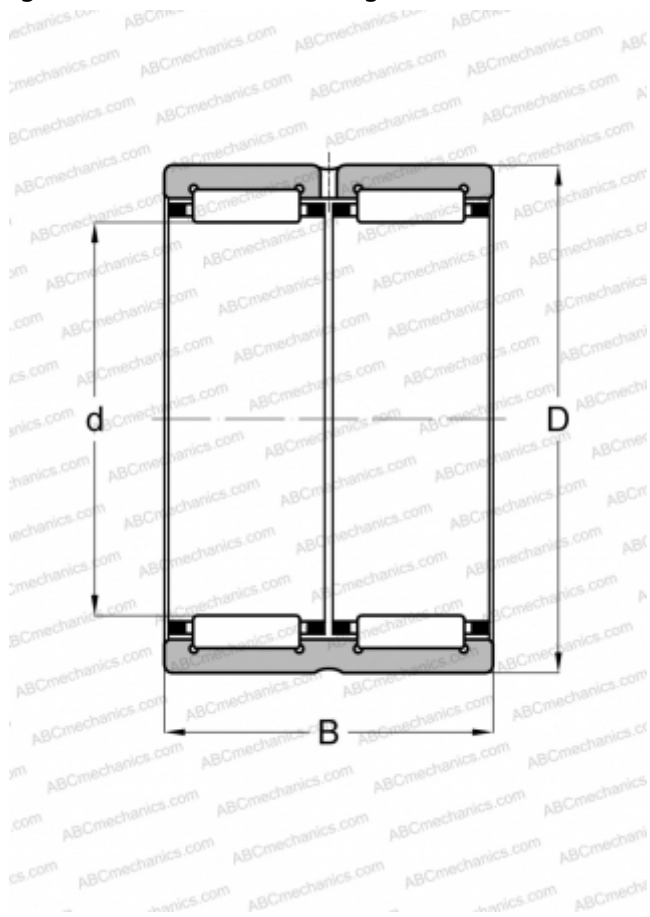

Technical specification

DIMENSIONS, MM

d	42,000
D	55,000
B	36,000

WEIGHT, KG

0,200

MANUFACTURER

[IKO](#)

INTERCHANGE

ABC	RNA 6907 2RS
-----	------------------------------

CALCULATION DATA

Basic dynamic load rating, C	51,600 kN
Basic static load rating, Co	92,600 kN