

AS 1730 IKO

Axial bearing washer

TYPE: Rolling bearing parts and accessories, Rolling elements, Axial bearing washers, Type AS, suitable for AXK AND K811..

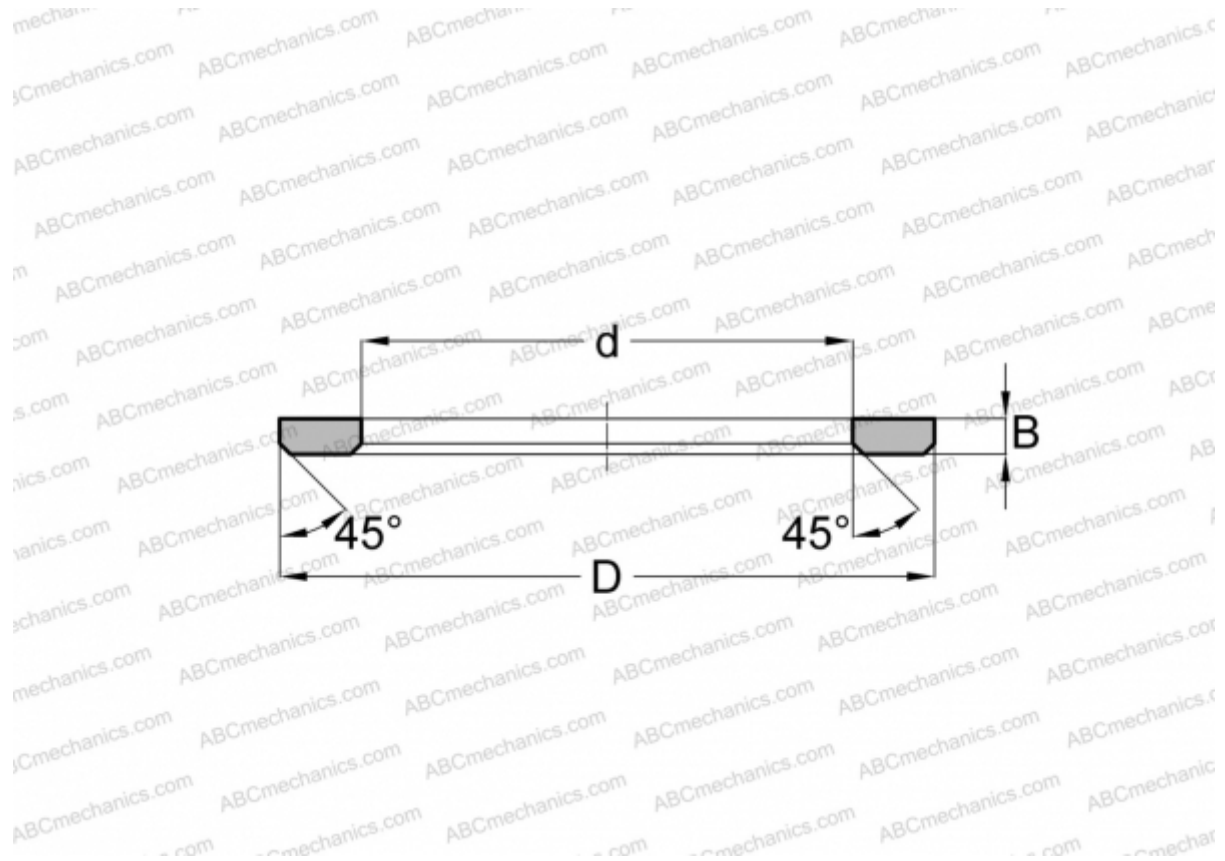

Technical specification

DIMENSIONS, MM

d	17,000
D	30,000
B	1,000

WEIGHT, KG 0,004

MANUFACTURER [IKO](#)

INTERCHANGE

ABC	AS1730
FAG	AS1730
INA	AS1730
NTN	AAS 1103
SKF	AS1730/ XWA173001
TORRINGTON	FTRA-1730