

AS 1831 ABC

Axial bearing washer

TYPE: Rolling bearing parts and accessories, Rolling elements, Axial bearing washers, Type AS, suitable for AXK AND K811..

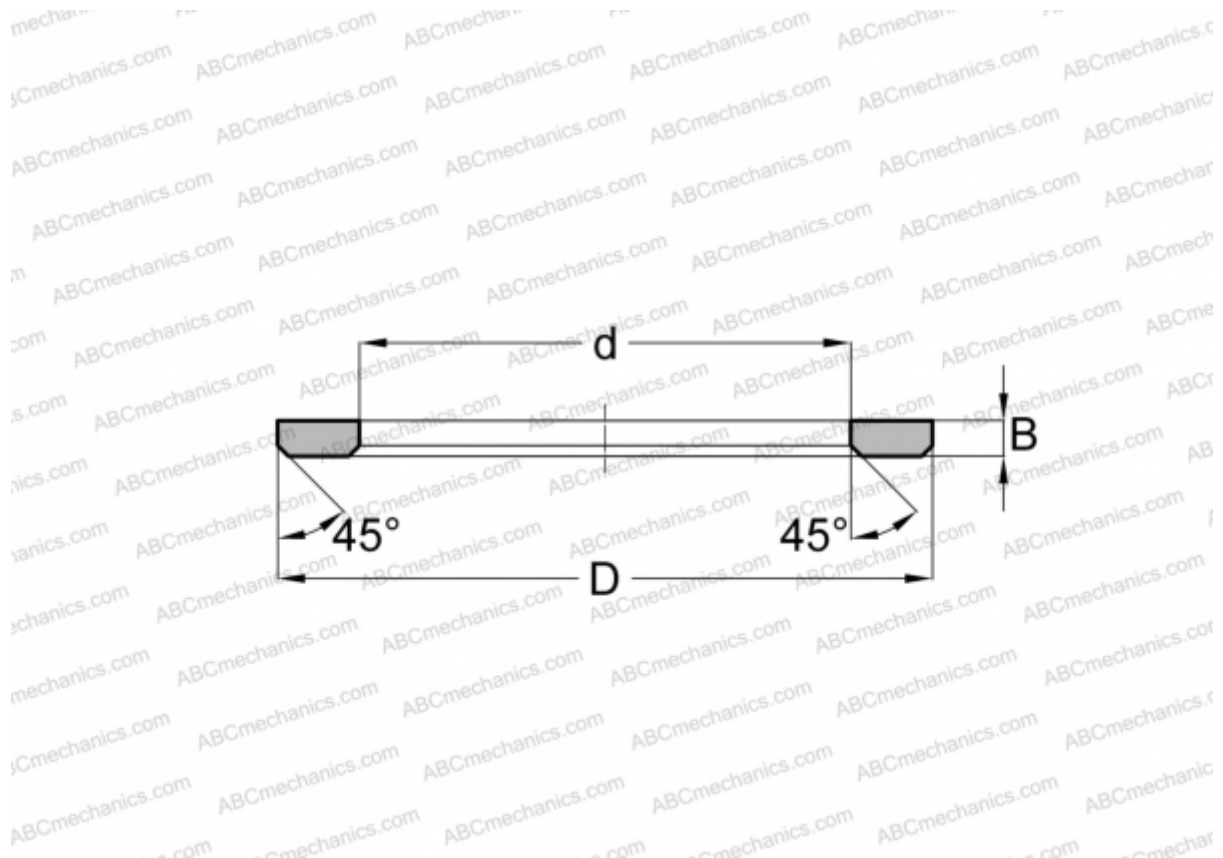

Technical specification

DIMENSIONS, MM

d	18,000
D	31,000
B	1,000

WEIGHT, KG 0,004

MANUFACTURER [ABC](#)

INTERCHANGE

IKO	AS 1831
-----	-------------------------