

AS 2542 IKO

Axial bearing washer

TYPE: Rolling bearing parts and accessories, Rolling elements, Axial bearing washers, Type AS, suitable for AXK AND K811..

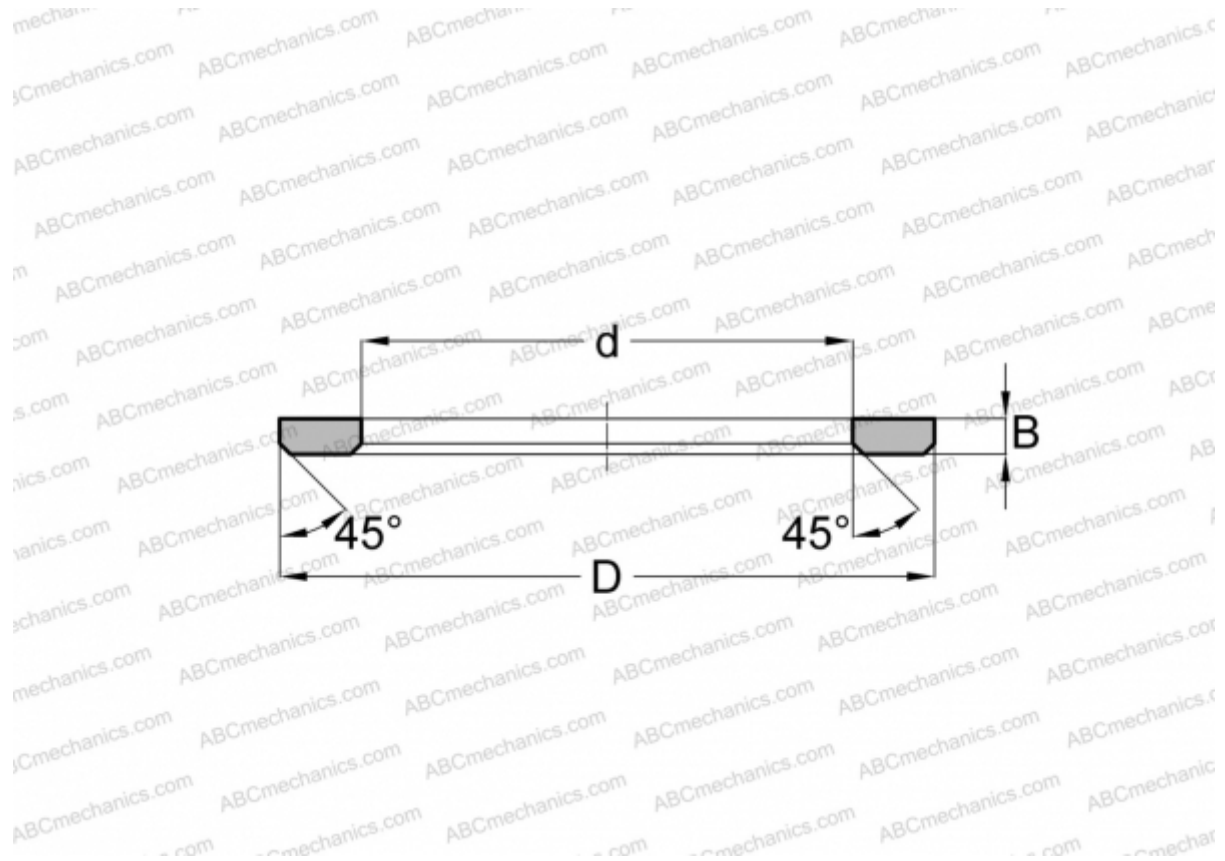

Technical specification

DIMENSIONS, MM

d	25,000
D	42,000
B	1,000

WEIGHT, KG 0,007

MANUFACTURER [IKO](#)

INTERCHANGE

ABC	AS2542
FAG	AS2542
INA	AS2542
NTN	AAS 1105
SKF	AS2542/ XWA254201
TORRINGTON	FTRA-2542