

AS 3047 IKO

Axial bearing washer

TYPE: Rolling bearing parts and accessories, Rolling elements, Axial bearing washers, Type AS, suitable for AXK AND K811..

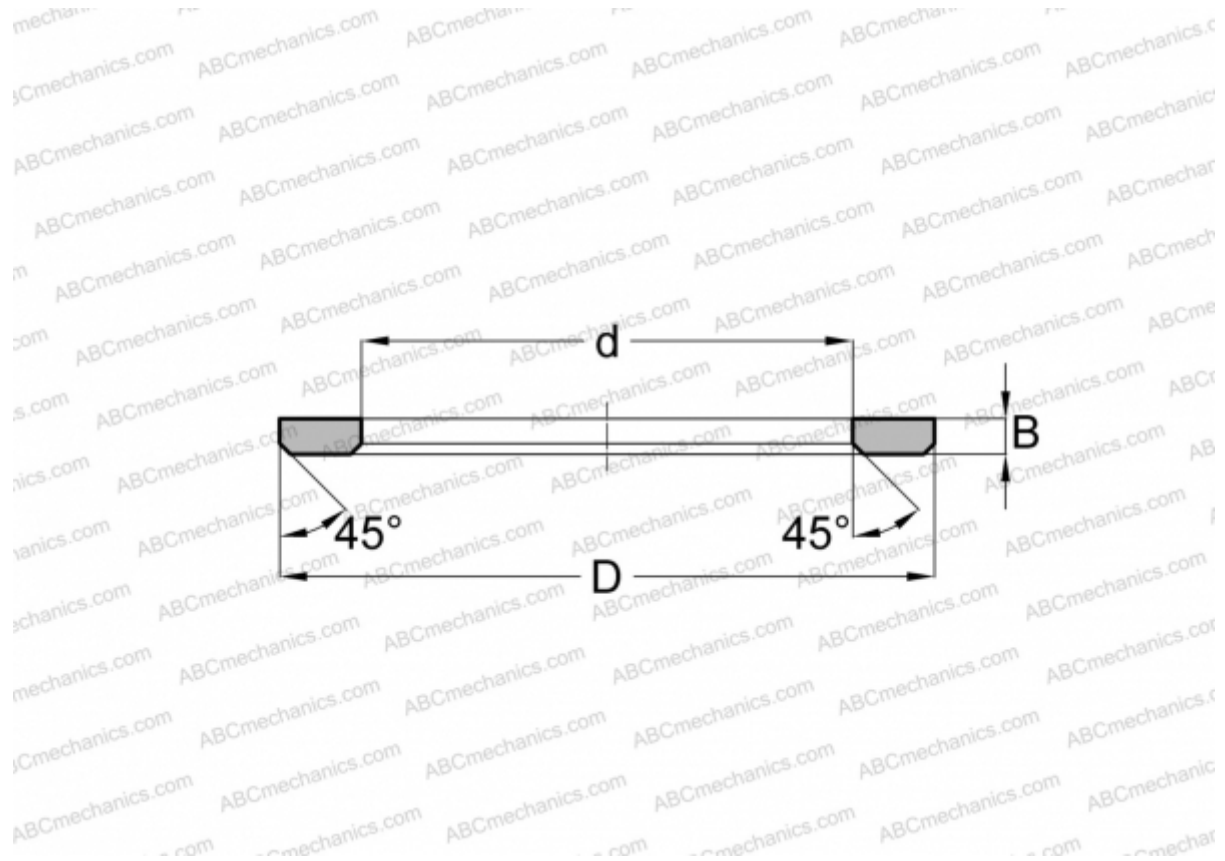

Technical specification

DIMENSIONS, MM

d	30,000
D	47,000
B	1,000

WEIGHT, KG 0,008

MANUFACTURER [IKO](#)

INTERCHANGE

ABC	AS3047
FAG	AS3047
INA	AS3047
NTN	AAS 1106
SKF	AS3047/ XWA304701
TORRINGTON	FTRA-3047