

AS 3552 IKO

Axial bearing washer

TYPE: Rolling bearing parts and accessories, Rolling elements, Axial bearing washers, Type AS, suitable for AXK AND K811..

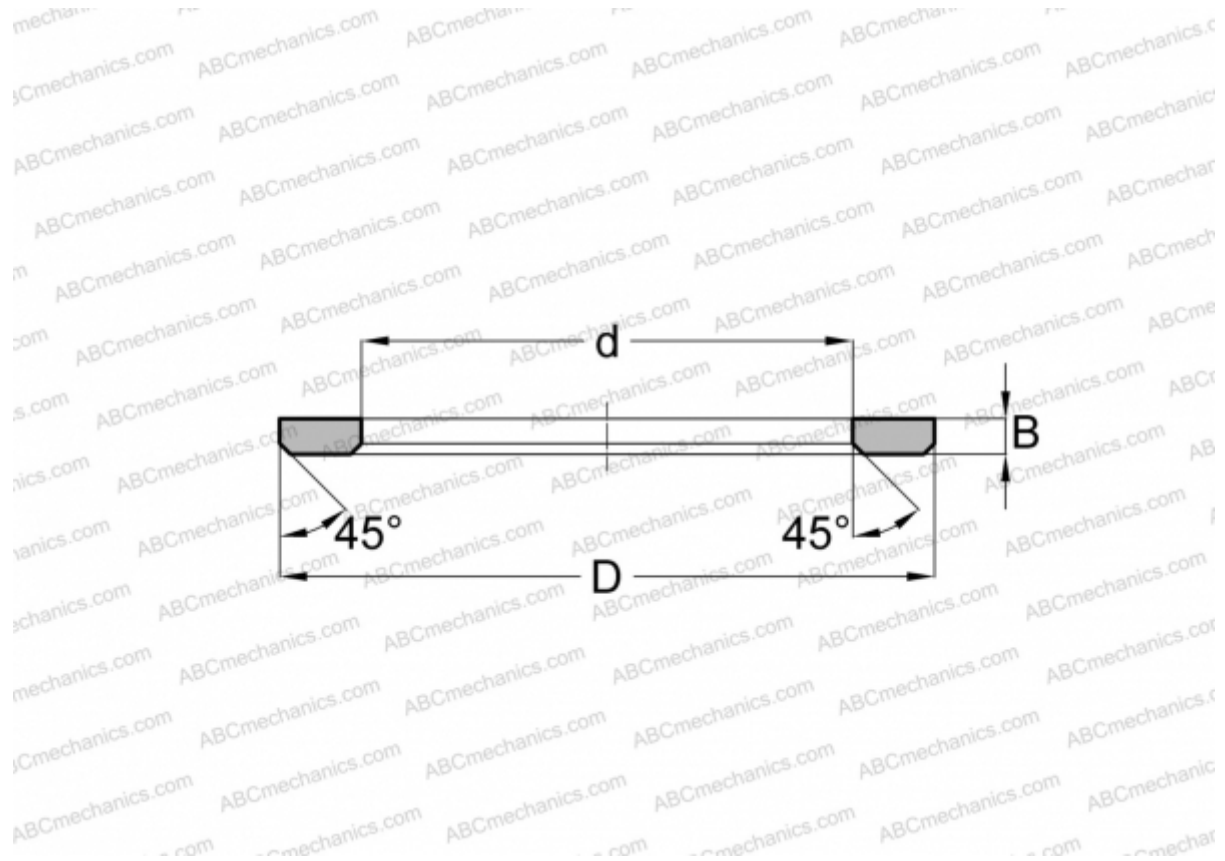

Technical specification

DIMENSIONS, MM

d	35,000
D	52,000
B	1,000

WEIGHT, KG 0,009

MANUFACTURER [IKO](#)

INTERCHANGE

ABC	AS3552
FAG	AS3552
INA	AS3552
NTN	AAS 1107
SKF	AS3552/ XWA355201
TORRINGTON	FTRA-3552