

AS 80105 IKO

Axial bearing washer

TYPE: Rolling bearing parts and accessories, Rolling elements, Axial bearing washers, Type AS, suitable for AXK AND K811..

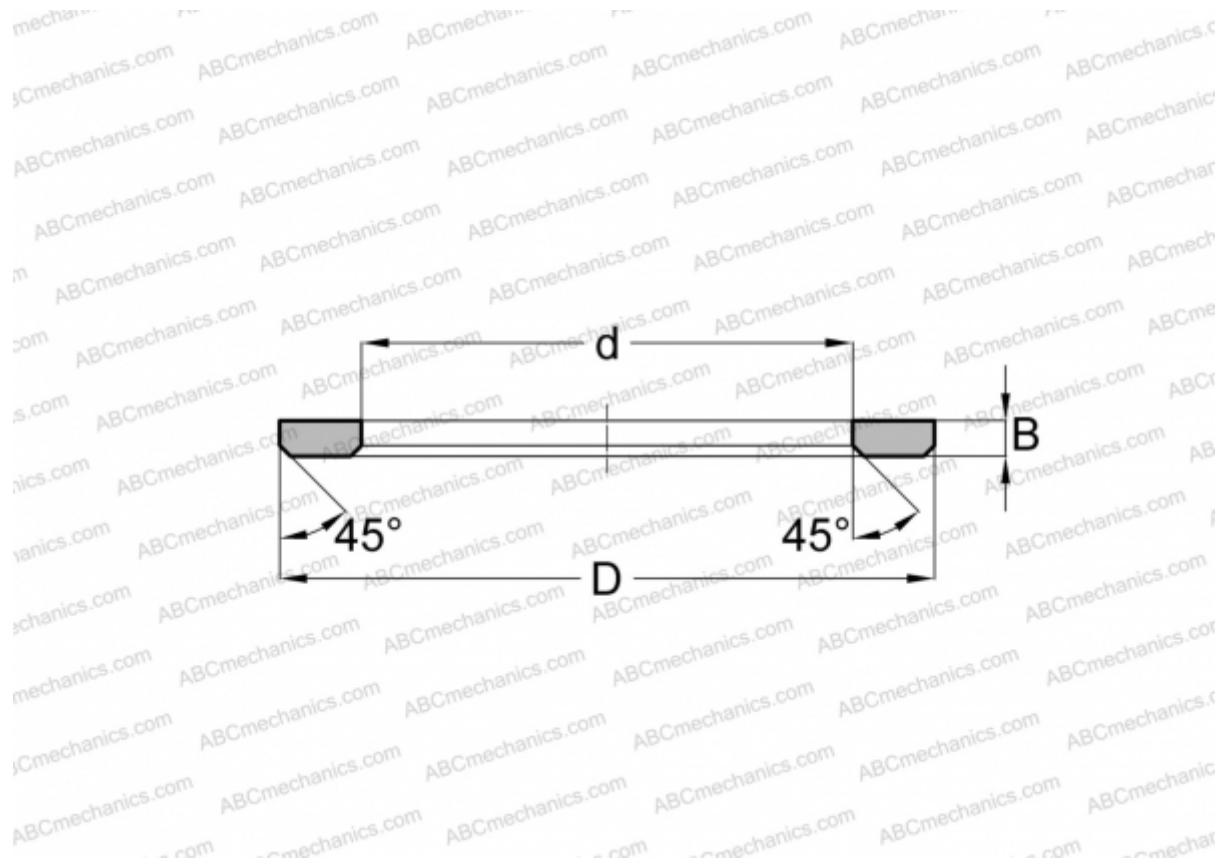

Technical specification

DIMENSIONS, MM

d	80,000
D	105,000
B	1,000

WEIGHT, KG 0,028

MANUFACTURER [IKO](#)

INTERCHANGE

ABC	AS80105
FAG	AS80105
INA	AS80105
NTN	AAS 1116
SKF	AS80105/ XWA8010501
TORRINGTON	FTRA-80105