

AS160200 ABC

Axial bearing washer

TYPE: Rolling bearing parts and accessories, Rolling elements, Axial bearing washers, Type AS, suitable for AXK AND K811..

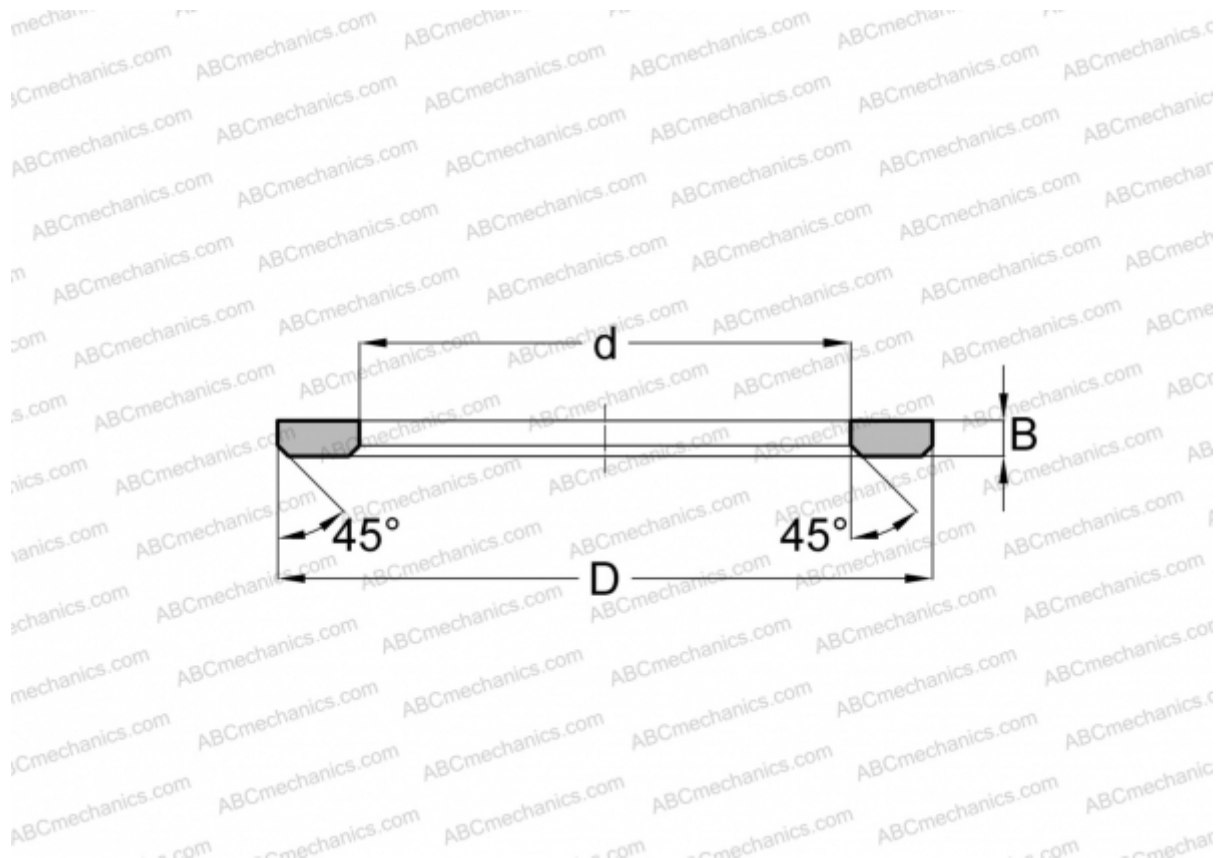

Technical specification

DIMENSIONS, MM

d	160,000
D	200,000
B	1,000

WEIGHT, KG 0,091

MANUFACTURER [ABC](#)

INTERCHANGE

FAG	AS160200
INA	AS160200
NTN	AAS 1132
SKF	AS160200/ XWA16020001