

## 81102 SKF

Cylindrical roller thrust bearings

TYPE: Roller bearings, Thrust roller bearing, Cylindrical, Single direction

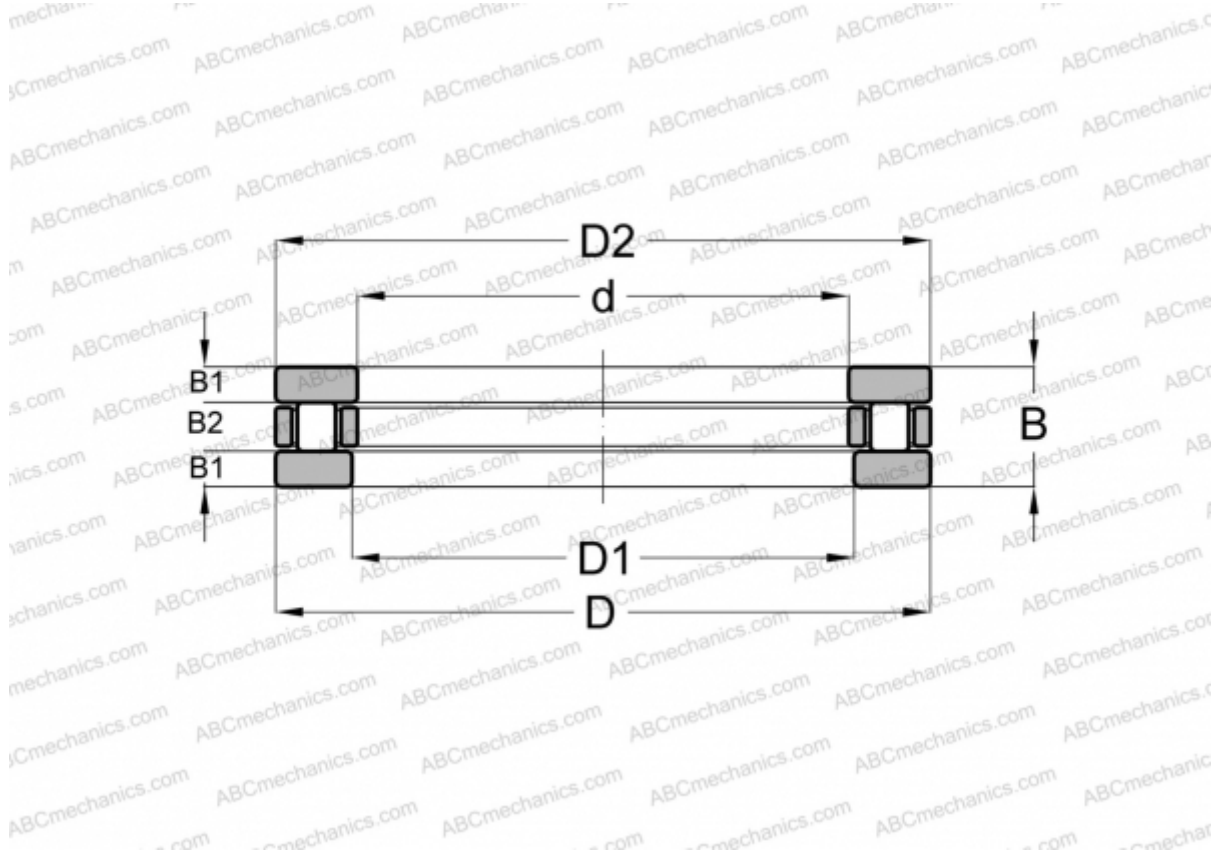

### Technical specification

#### DIMENSIONS, MM

d	15,000
D	28,000
D1	16,000
D2	28,000
B	9,000
B1	2,750
B2	3,500

**WEIGHT, KG** 0,027

**MANUFACTURER** [SKF](#)

#### INTERCHANGE

ABC	<a href="#">81102</a>
INA	<a href="#">81102 TN</a>
IKO	<a href="#">AZ 15289</a>