

81105 TN INA

Cylindrical roller thrust bearings

TYPE: Roller bearings, Thrust roller bearing, Cylindrical, Single direction

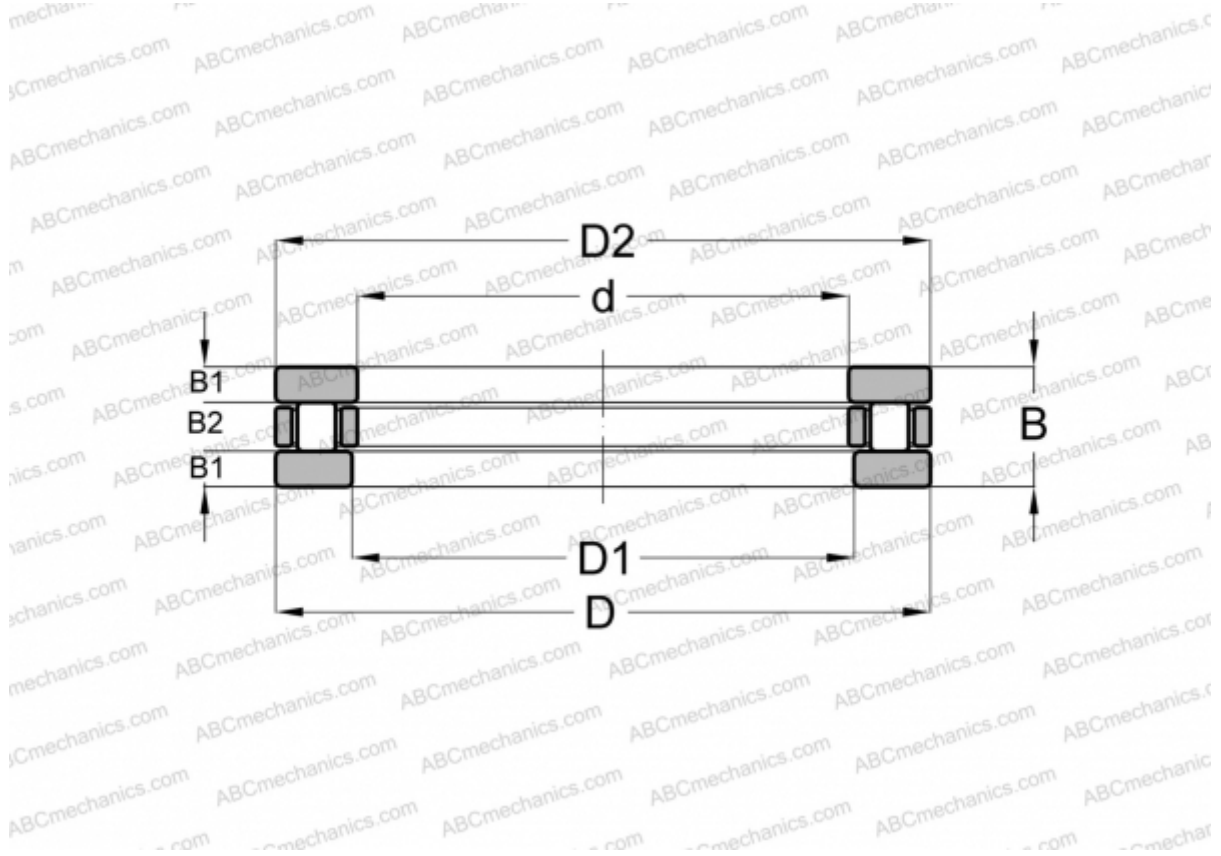

Technical specification

DIMENSIONS, MM

d	25,000
D	42,000
D1	26,000
D2	42,000
B	11,000
B1	3,000
B2	5,000

WEIGHT, KG 0,064

MANUFACTURER [INA](#)

INTERCHANGE

ABC	81105
SKF	81105
IKO	AZ 254211