

81106 ABC

Cylindrical roller thrust bearings

TYPE: Roller bearings, Thrust roller bearing, Cylindrical, Single direction

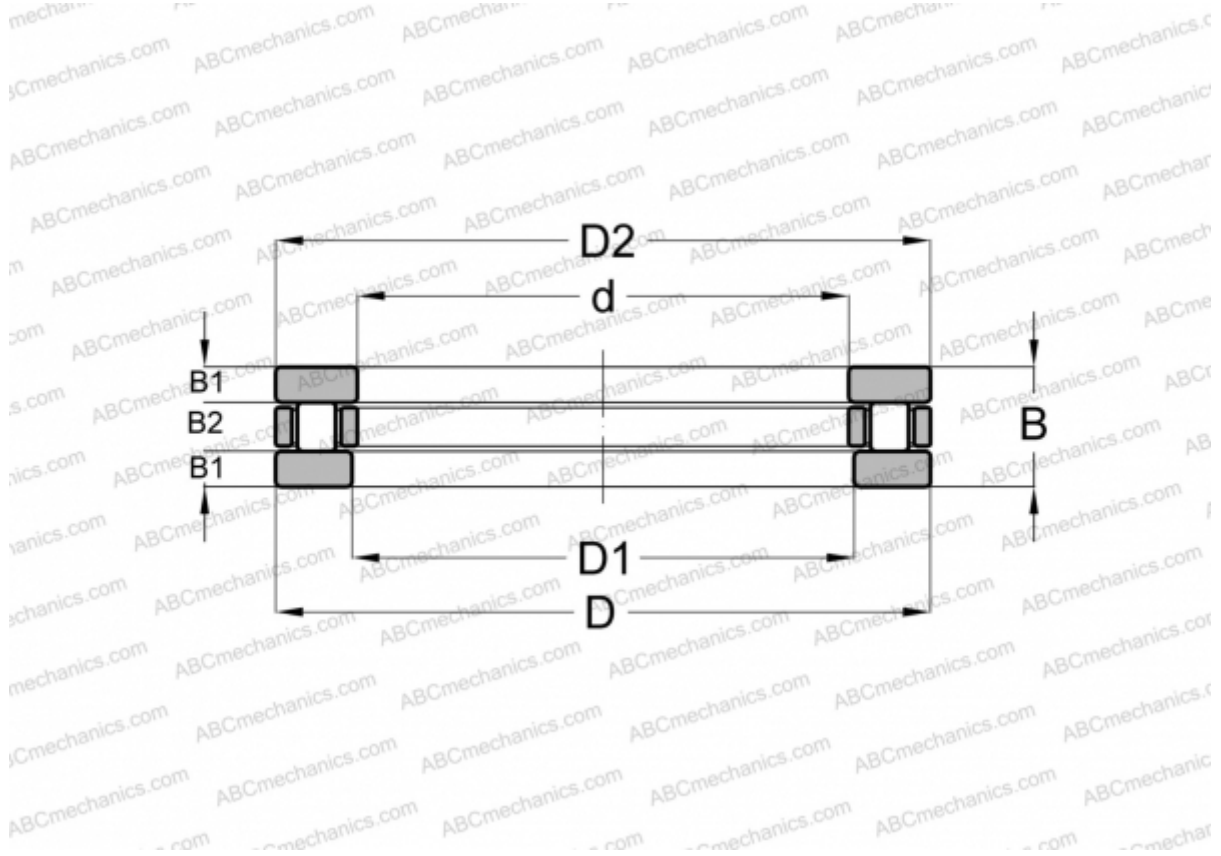

Technical specification

DIMENSIONS, MM

d	30,000
D	47,000
D1	32,000
D2	47,000
B	11,000
B1	3,000
B2	5,000

WEIGHT, KG 0,068

MANUFACTURER [ABC](#)

INTERCHANGE

SKF	81106
INA	81106 TN
IKO	AZ 304711