

81206 SKF

Cylindrical roller thrust bearings

TYPE: Roller bearings, Thrust roller bearing, Cylindrical, Single direction

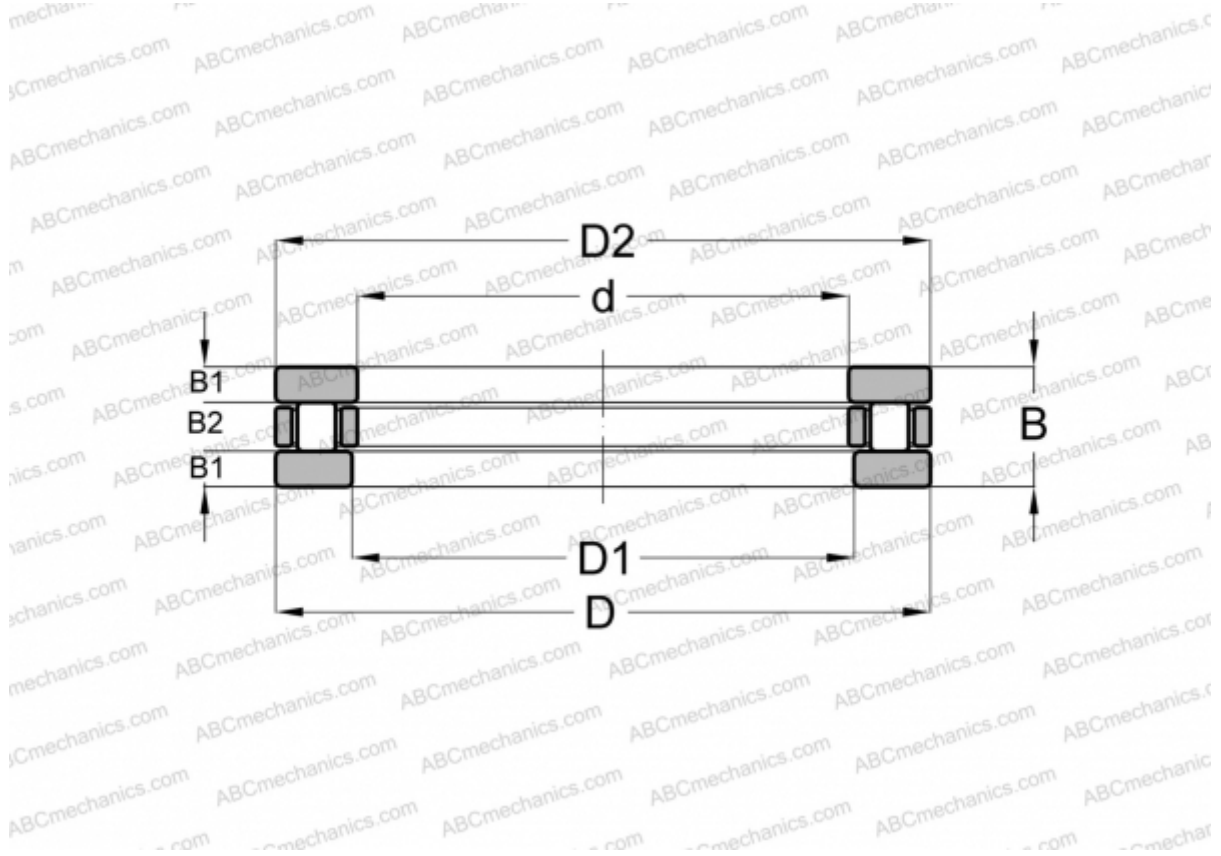

Technical specification

DIMENSIONS, MM

d	30,000
D	52,000
D1	32,000
D2	52,000
B	16,000
B1	4,250
B2	7,500

WEIGHT, KG 0,132

MANUFACTURER [SKF](#)

INTERCHANGE

ABC	81206
INA	81206 TN
IKO	AZ 305216