

81207 SKF

Cylindrical roller thrust bearings

TYPE: Roller bearings, Thrust roller bearing, Cylindrical, Single direction

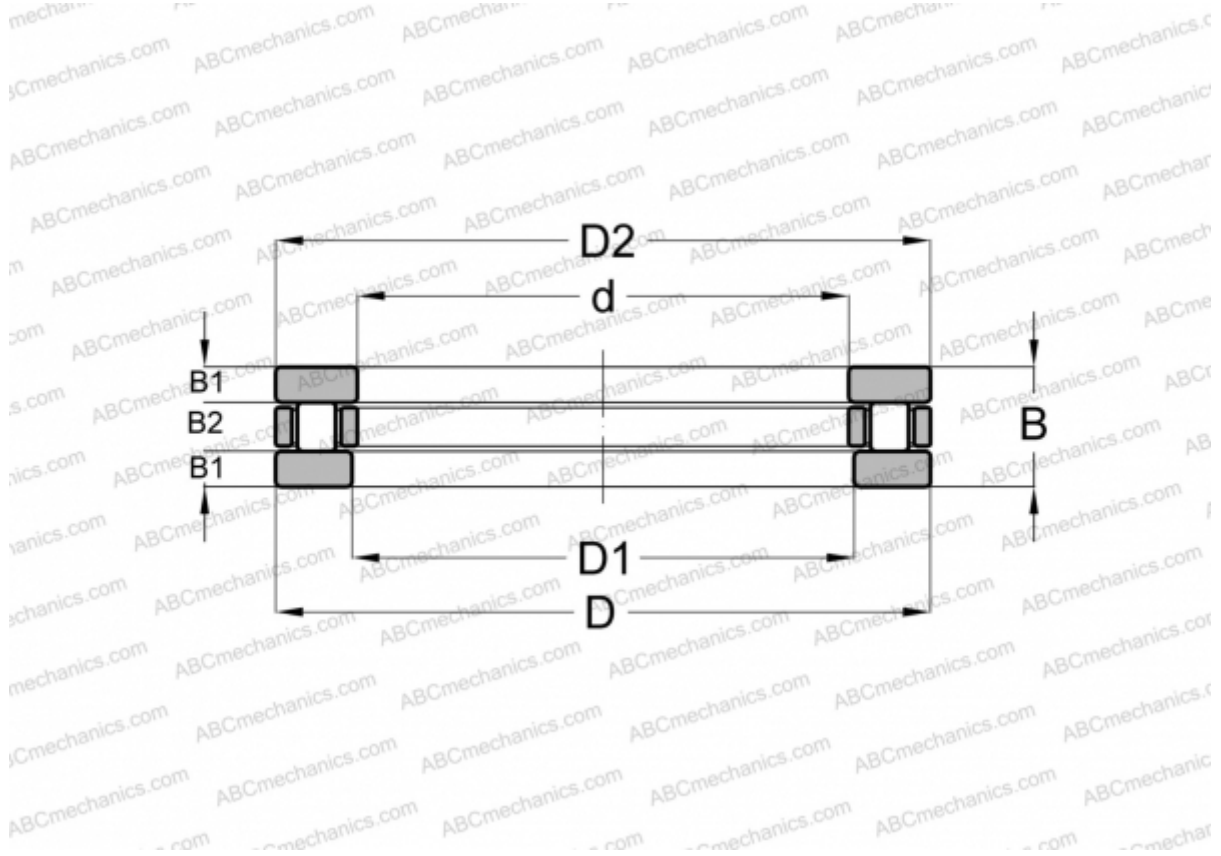

Technical specification

DIMENSIONS, MM

d	35,000
D	62,000
D1	37,000
D2	62,000
B	18,000
B1	5,250
B2	7,500

WEIGHT, KG 0,222

MANUFACTURER [SKF](#)

INTERCHANGE

ABC	81207
INA	81207 TN
IKO	AZ 356218