

81208 TN INA

Cylindrical roller thrust bearings

TYPE: Roller bearings, Thrust roller bearing, Cylindrical, Single direction

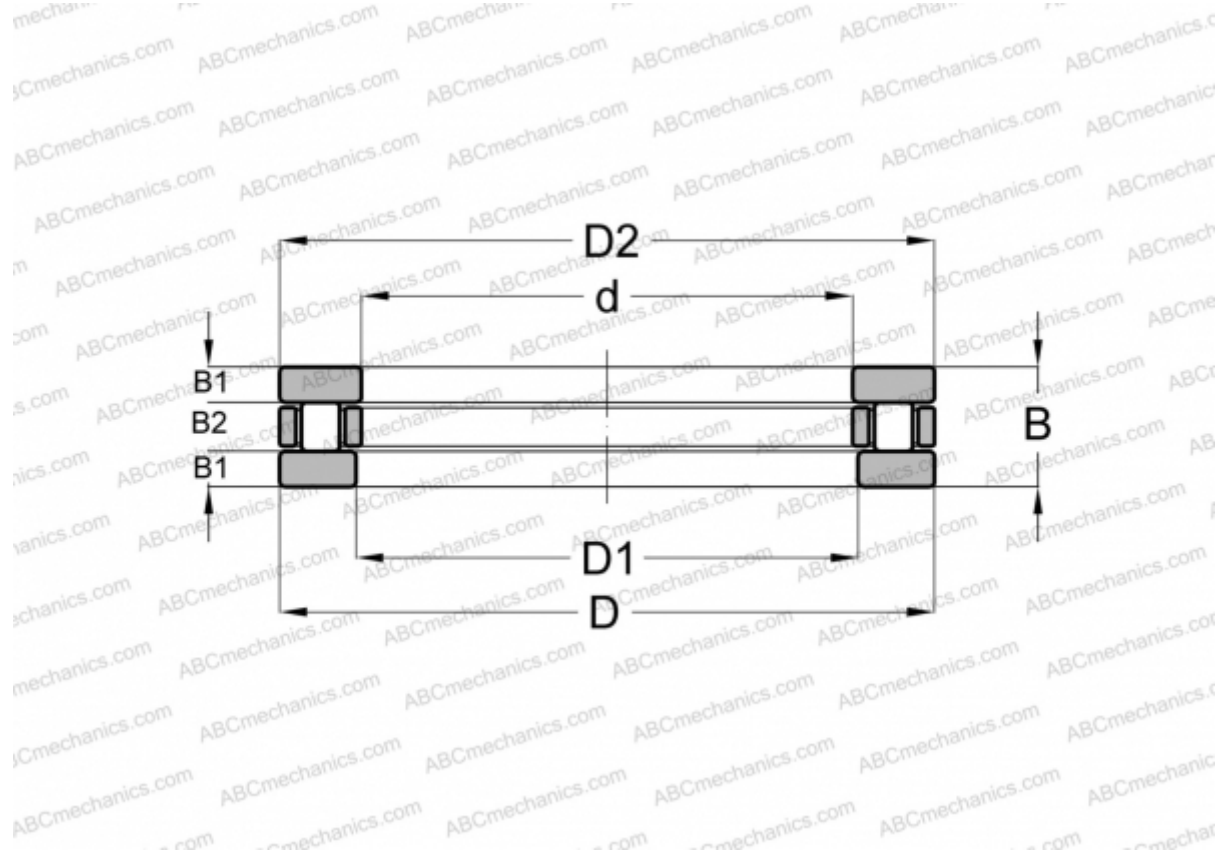

Technical specification

DIMENSIONS, MM

d	40,000
D	68,000
D1	42,000
D2	68,000
B	19,000
B1	5,000
B2	9,000

WEIGHT, KG 0,259

MANUFACTURER [INA](#)

INTERCHANGE

ABC	81208
SKF	81208
IKO	AZ 406819