

81209 ABC

Cylindrical roller thrust bearings

TYPE: Roller bearings, Thrust roller bearing, Cylindrical, Single direction

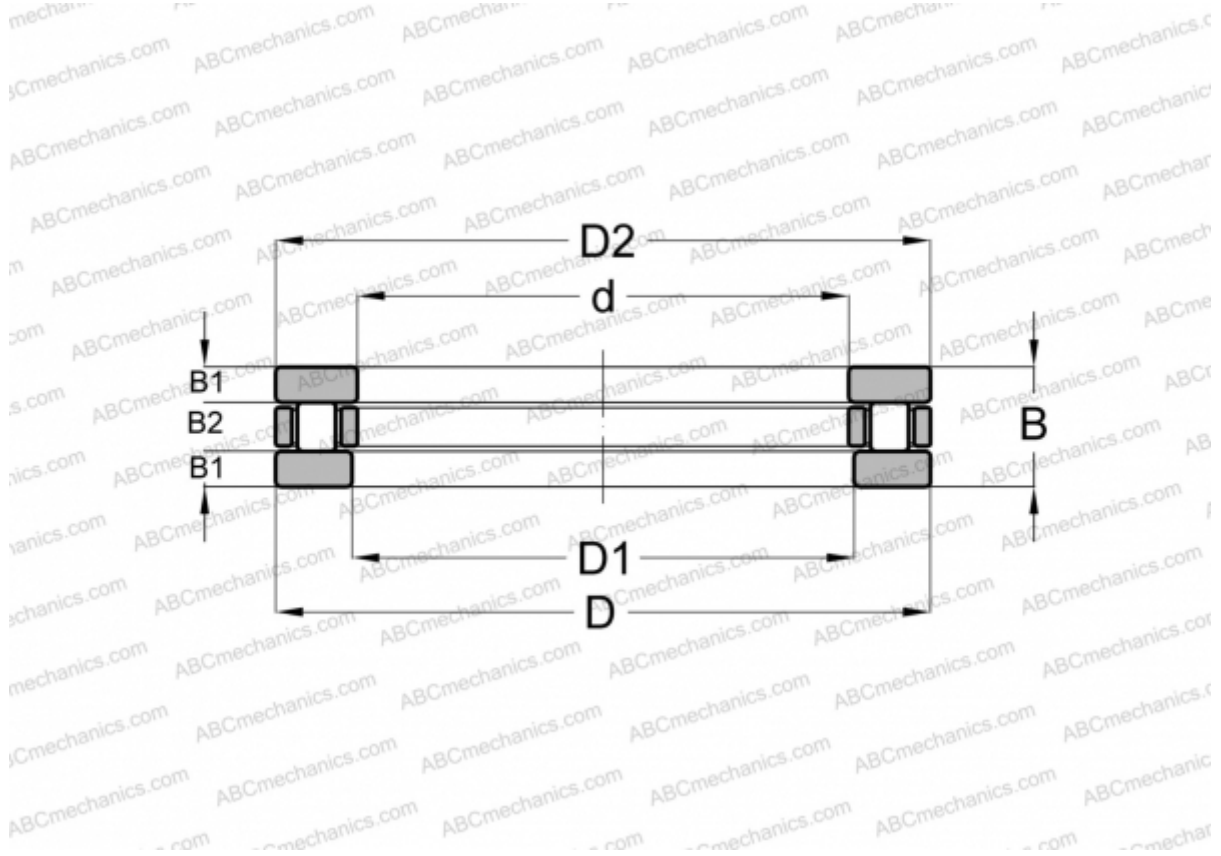

Technical specification

DIMENSIONS, MM

d	45,000
D	73,000
D1	47,000
D2	73,000
B	20,000
B1	5,500
B2	9,000

WEIGHT, KG 0,304

MANUFACTURER [ABC](#)

INTERCHANGE

SKF	81209
INA	81209 TN
IKO	AZ 457320