

81110 TN INA

Cylindrical roller thrust bearings

TYPE: Roller bearings, Thrust roller bearing, Cylindrical, Single direction

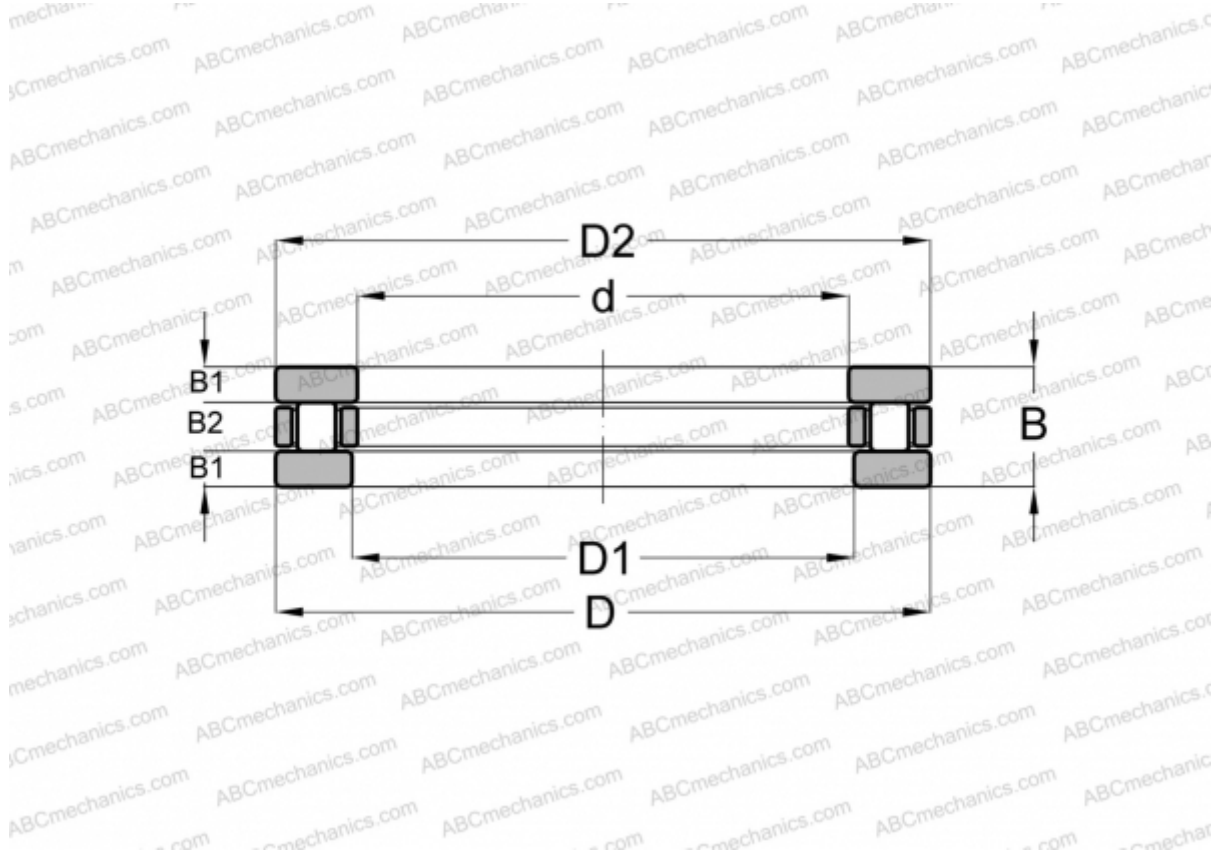

Technical specification

DIMENSIONS, MM

d	50,000
D	70,000
D1	52,000
D2	70,000
B	14,000
B1	4,000
B2	6,000

WEIGHT, KG 0,154

MANUFACTURER [INA](#)

INTERCHANGE

ABC	81110
SKF	81110
IKO	AZ 507014