

81210 TN INA

Cylindrical roller thrust bearings

TYPE: Roller bearings, Thrust roller bearing, Cylindrical, Single direction

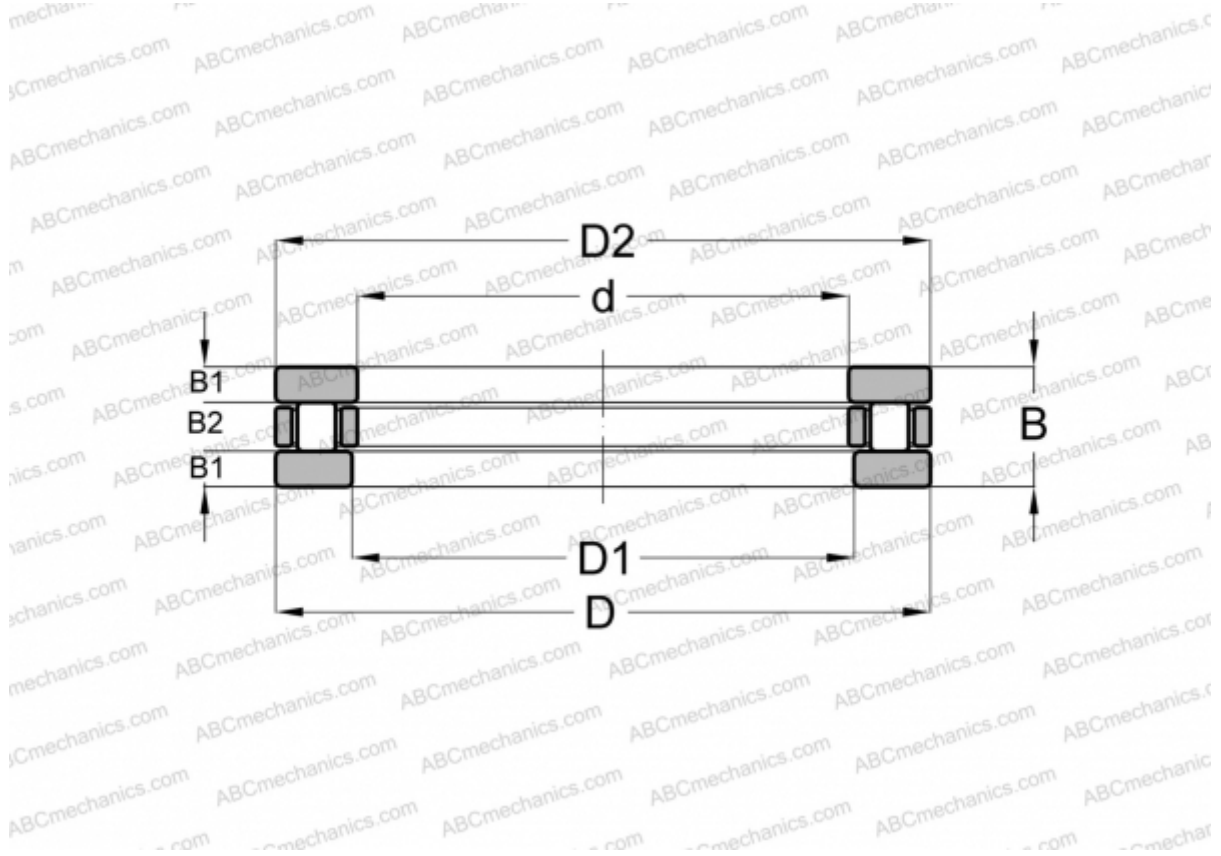

Technical specification

DIMENSIONS, MM

d	50,000
D	78,000
D1	52,000
D2	78,000
B	22,000
B1	6,500
B2	9,000

WEIGHT, KG 0,367

MANUFACTURER [INA](#)

INTERCHANGE

ABC	81210
SKF	81210
IKO	AZ 507822