

81111 ABC

Cylindrical roller thrust bearings

TYPE: Roller bearings, Thrust roller bearing, Cylindrical, Single direction

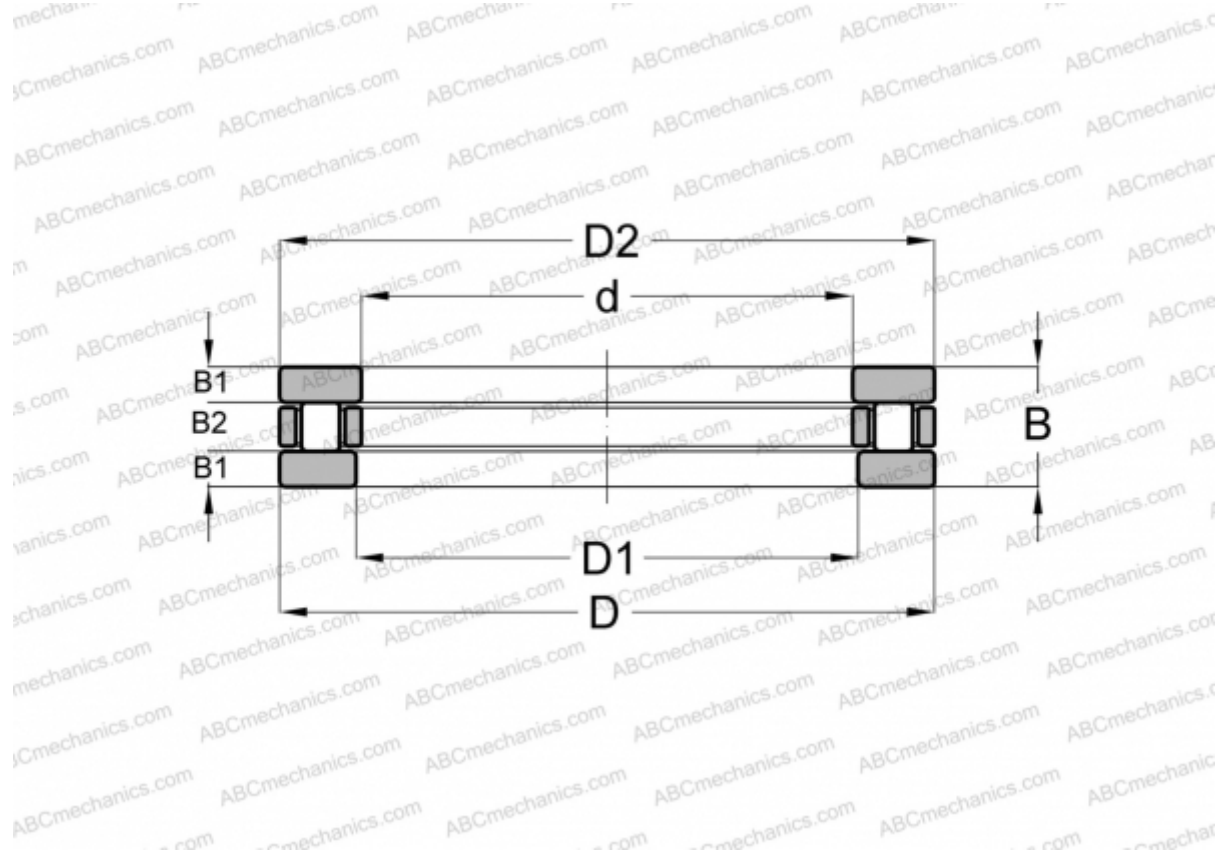

Technical specification

DIMENSIONS, MM

d	55,000
D	78,000
D1	57,000
D2	78,000
B	16,000
B1	5,000
B2	6,000

WEIGHT, KG 0,236

MANUFACTURER [ABC](#)

INTERCHANGE

SKF	81111
INA	81111 TN
IKO	AZ 557816