

81211 TN INA

Cylindrical roller thrust bearings

TYPE: Roller bearings, Thrust roller bearing, Cylindrical, Single direction

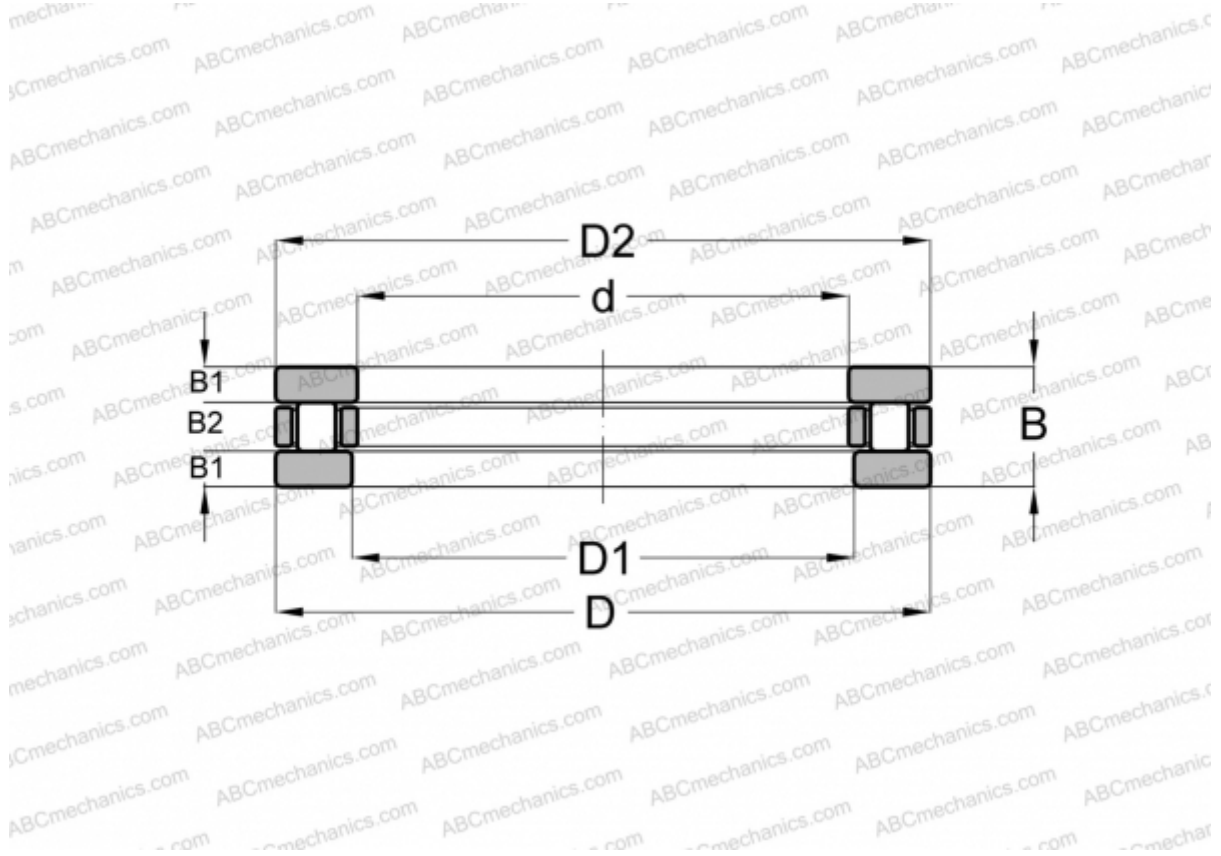

Technical specification

DIMENSIONS, MM

d	55,000
D	90,000
D1	57,000
D2	90,000
B	25,000
B1	7,000
B2	11,000

WEIGHT, KG 0,585

MANUFACTURER [INA](#)

INTERCHANGE

ABC	81211
SKF	81211
IKO	AZ 559025