

## AZ 559025 IKO

Cylindrical roller thrust bearings

TYPE: Roller bearings, Thrust roller bearing, Cylindrical, Single direction

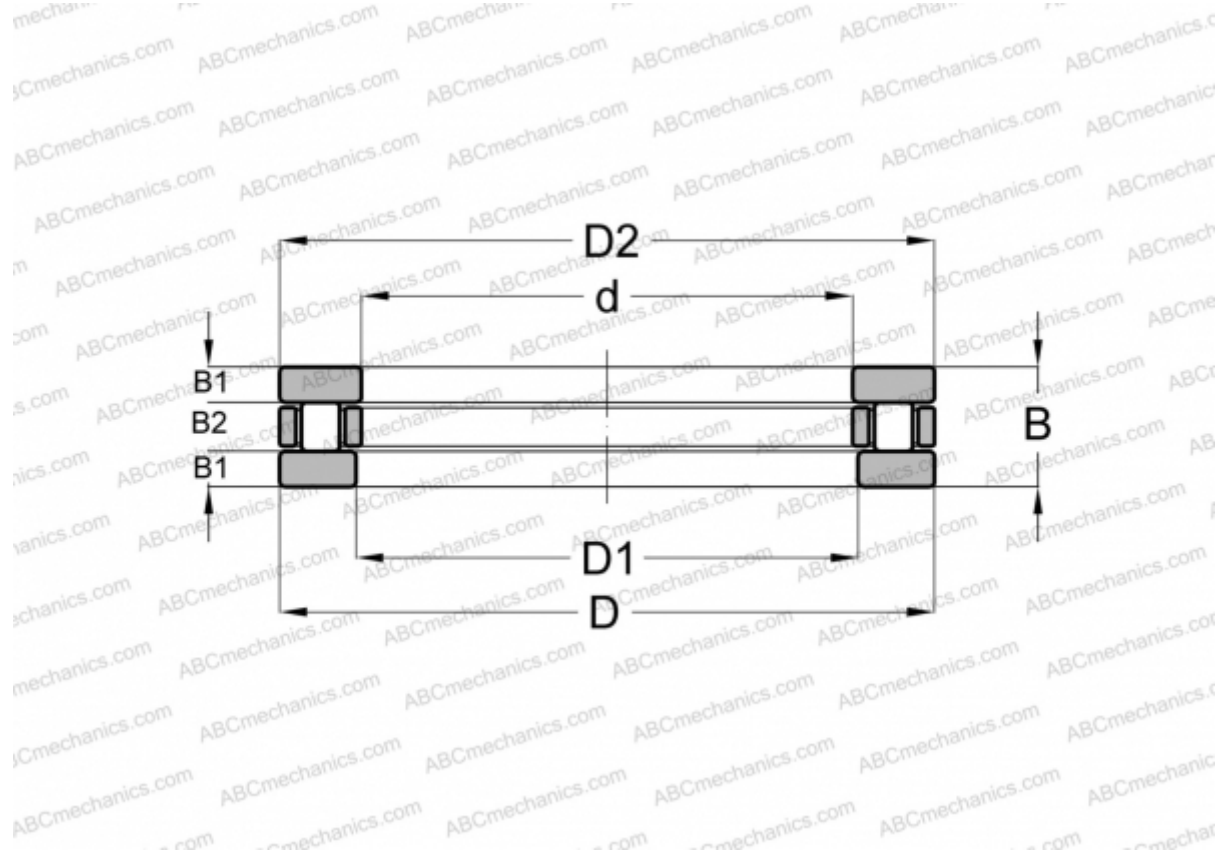

### Technical specification

#### DIMENSIONS, MM

d	55,000
D	90,000
D1	55,050
B	25,000
B1	7,000
B2	11,000

**WEIGHT, KG** 0,725

**MANUFACTURER** [IKO](#)

#### INTERCHANGE

ABC	<a href="#">81211</a>
SKF	<a href="#">81211</a>
INA	<a href="#">81211 TN</a>

#### INCLUDED PRODUCTS

AZK 559011, GS 5590, WS 5590

#### CALCULATION DATA

Basic dynamic load rating, C	108,000 kN
Basic static load rating, Co	332,000 kN