

81113 SKF

Cylindrical roller thrust bearings

TYPE: Roller bearings, Thrust roller bearing, Cylindrical, Single direction

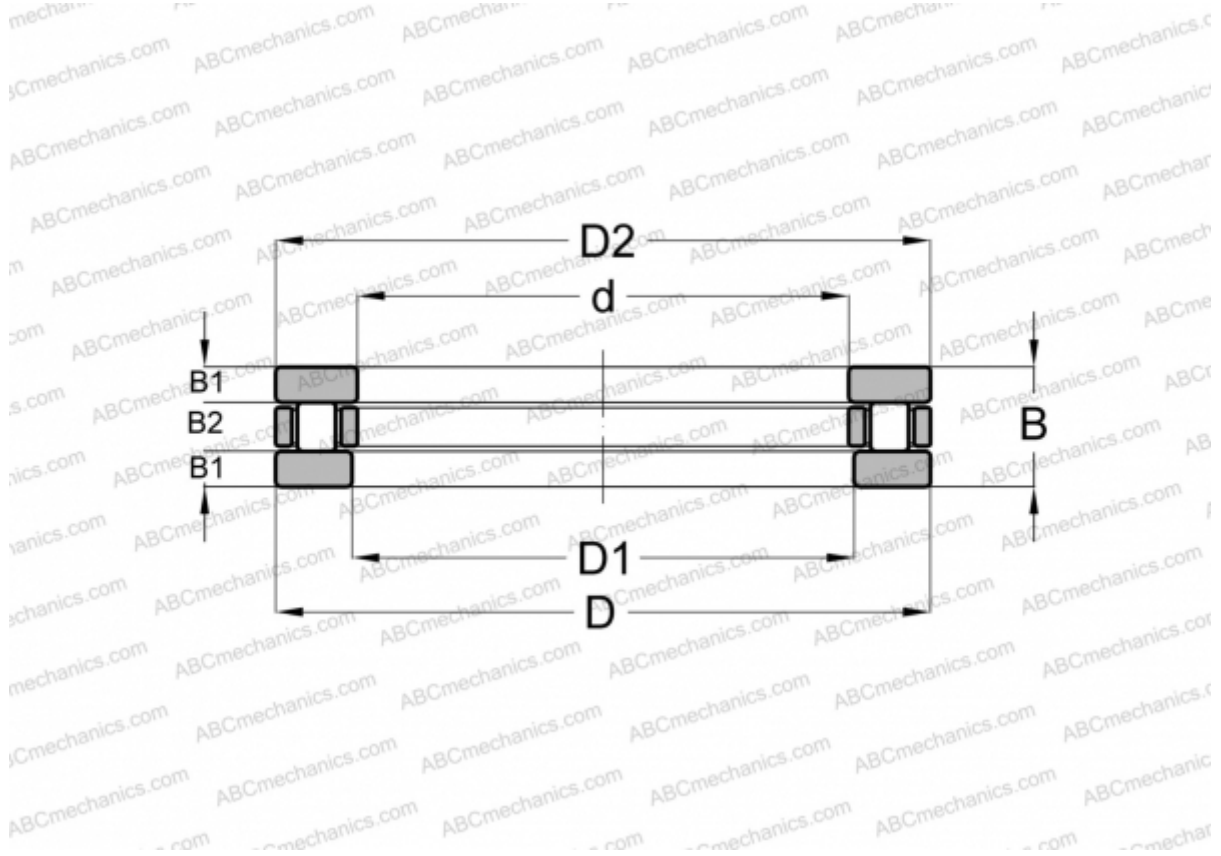

Technical specification

DIMENSIONS, MM

d	65,000
D	90,000
D1	67,000
D2	90,000
B	18,000
B1	5,250
B2	7,500

WEIGHT, KG 0,327

MANUFACTURER [SKF](#)

INTERCHANGE

ABC	81113
INA	81113 TN
IKO	AZ 659018