

81213 TN INA

Cylindrical roller thrust bearings

TYPE: Roller bearings, Thrust roller bearing, Cylindrical, Single direction

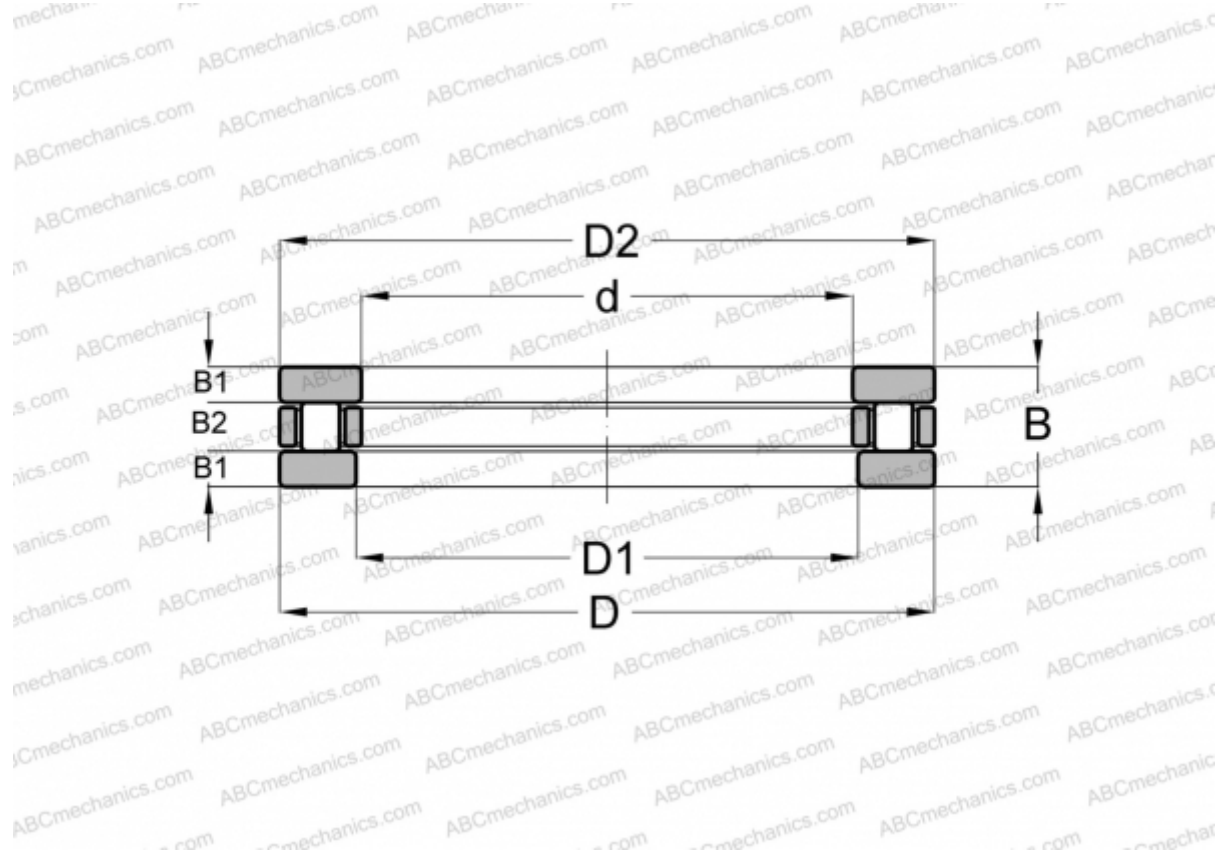

Technical specification

DIMENSIONS, MM

d	65,000
D	100,000
D1	67,000
D2	100,000
B	27,000
B1	8,000
B2	11,000

WEIGHT, KG 0,735

MANUFACTURER [INA](#)

INTERCHANGE

ABC	81213
SKF	81213
IKO	AZ 6510027