

81114 TN INA

Cylindrical roller thrust bearings

TYPE: Roller bearings, Thrust roller bearing, Cylindrical, Single direction

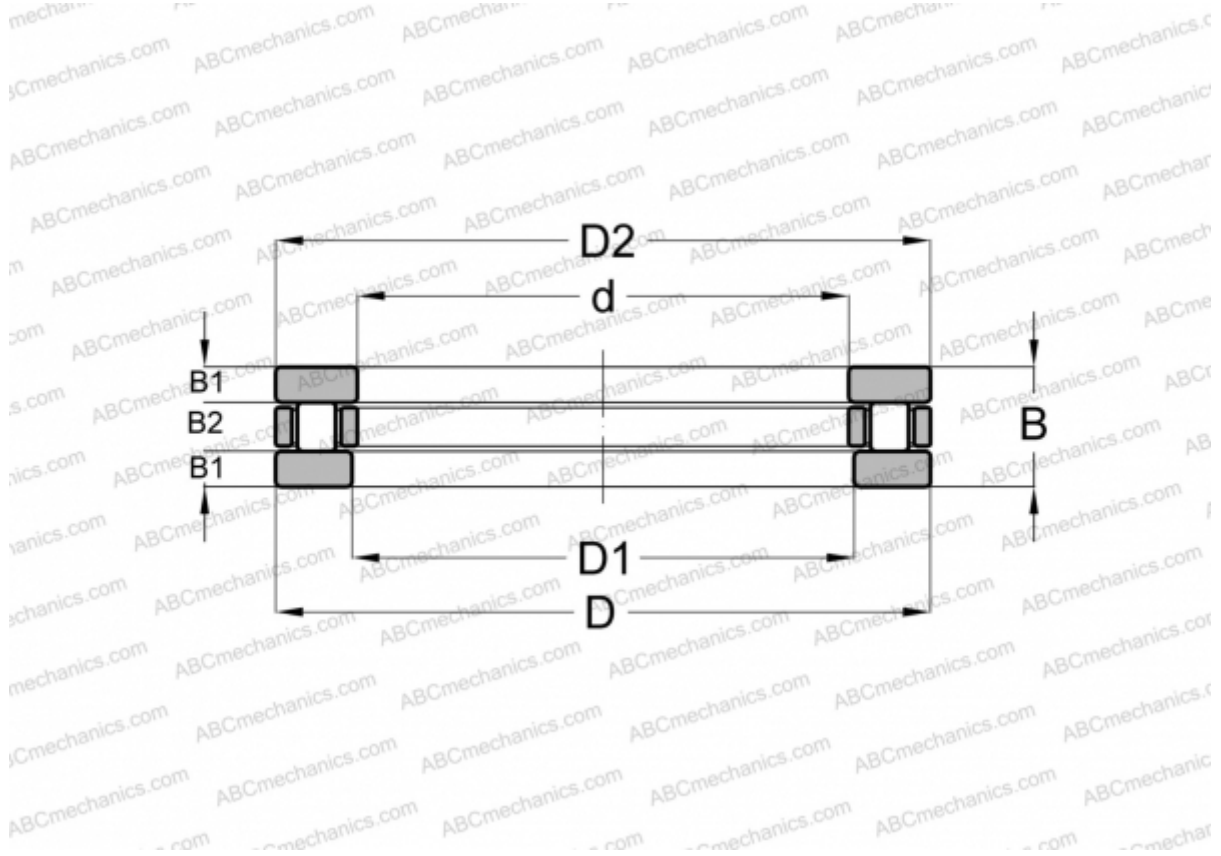

Technical specification

DIMENSIONS, MM

d	70,000
D	95,000
D1	72,000
D2	95,000
B	18,000
B1	5,250
B2	7,500

WEIGHT, KG 0,345

MANUFACTURER [INA](#)

INTERCHANGE

ABC	81114
SKF	81114
IKO	AZ 709518