

81115 INA

Cylindrical roller thrust bearings

TYPE: Roller bearings, Thrust roller bearing, Cylindrical, Single direction

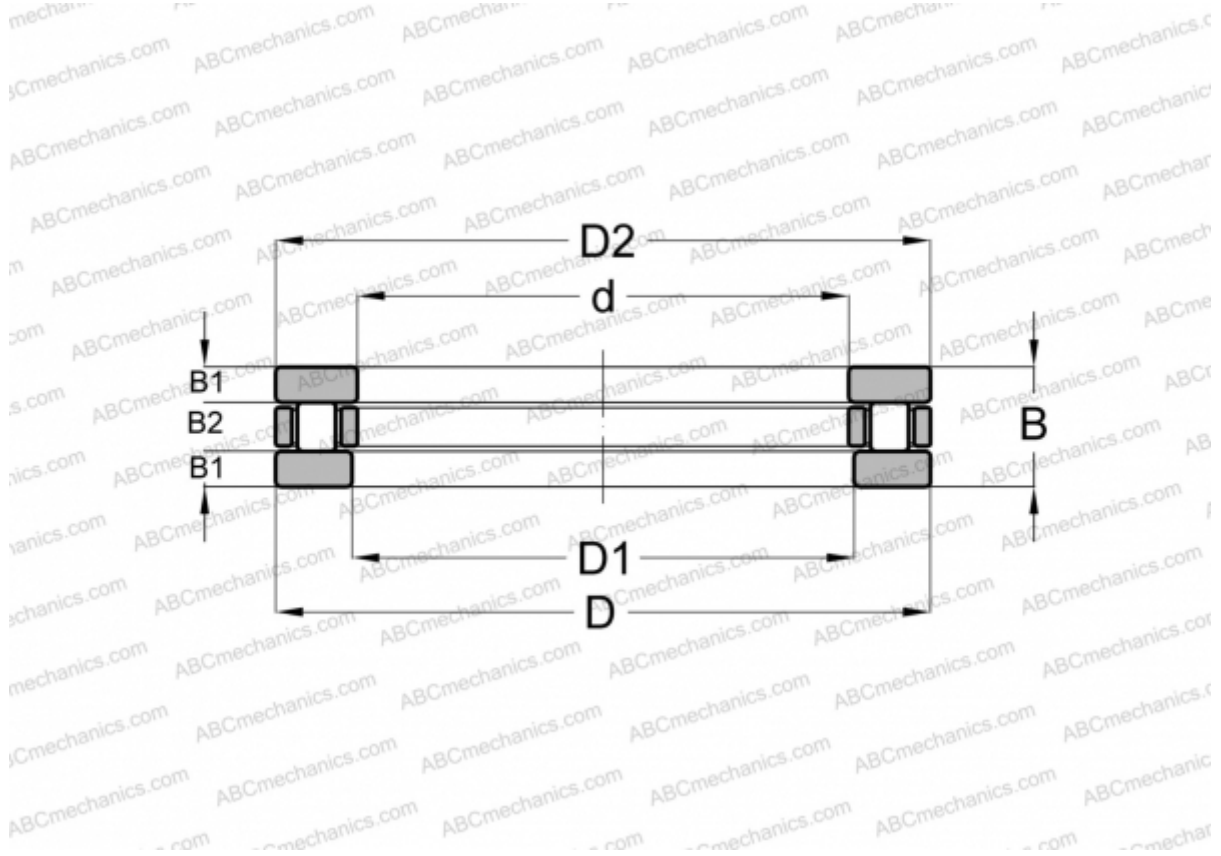

Technical specification

DIMENSIONS, MM

d	75,000
D	100,000
D1	77,000
D2	100,000
B	19,000
B1	5,750
B2	7,500

WEIGHT, KG 0,395

MANUFACTURER [INA](#)

INTERCHANGE

ABC	81115
SKF	81115
IKO	AZ 7510019