

## 81215 INA

Cylindrical roller thrust bearings

TYPE: Roller bearings, Thrust roller bearing, Cylindrical, Single direction

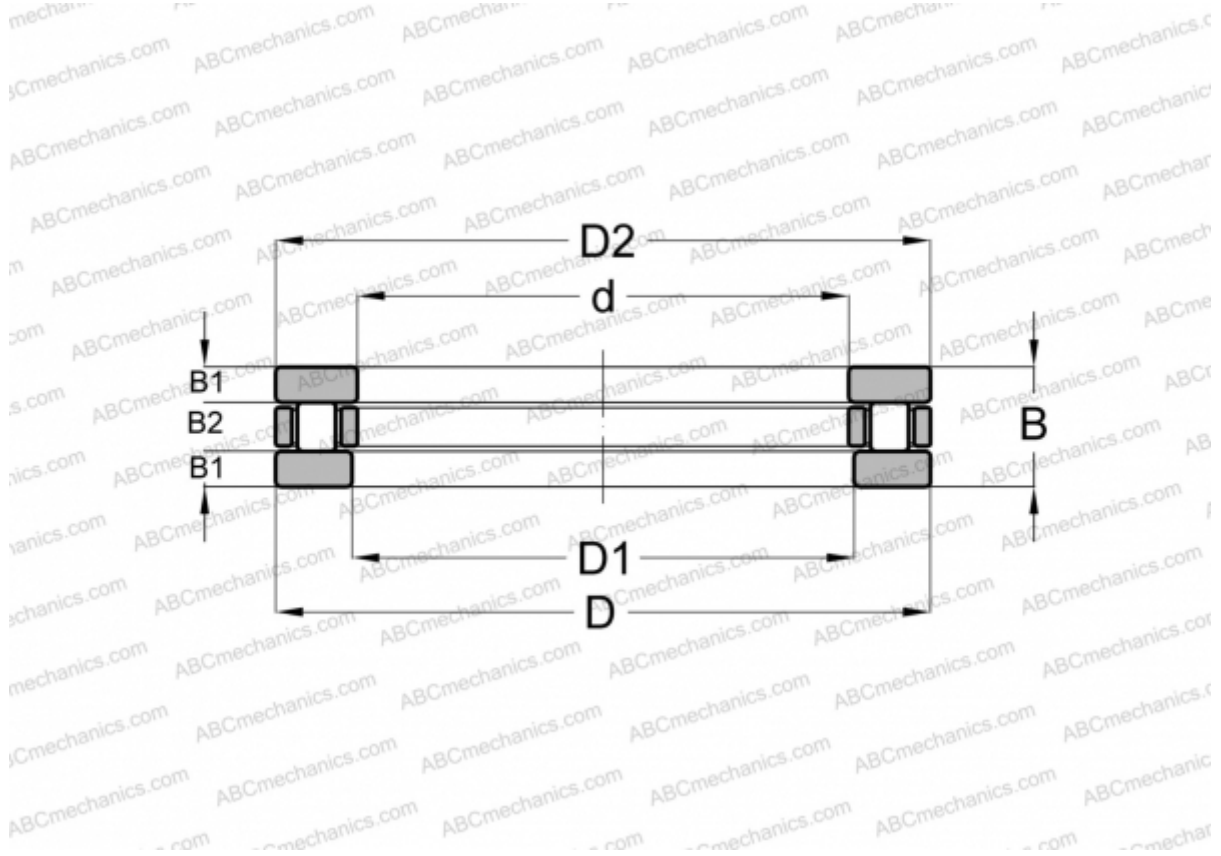

### Technical specification

#### DIMENSIONS, MM

d	75,000
D	110,000
D1	77,000
D2	110,000
B	27,000
B1	8,000
B2	11,000

**WEIGHT, KG** 0,821

**MANUFACTURER** [INA](#)

#### INTERCHANGE

ABC	<a href="#">81215</a>
SKF	<a href="#">81215</a>
IKO	<a href="#">AZ 7511027</a>