

81117 ABC

Cylindrical roller thrust bearings

TYPE: Roller bearings, Thrust roller bearing, Cylindrical, Single direction

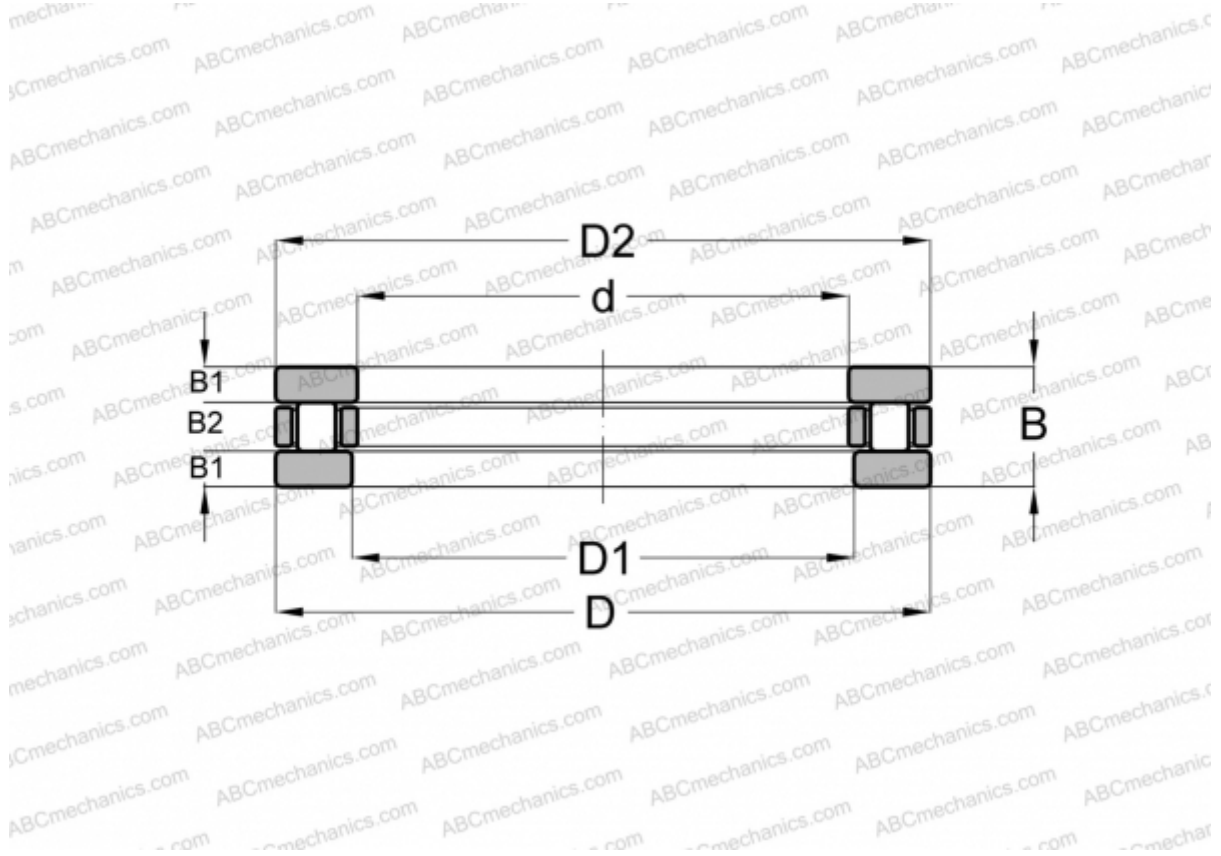

Technical specification

DIMENSIONS, MM

d	85,000
D	110,000
D1	87,000
D2	110,000
B	19,000
B1	5,750
B2	7,500

WEIGHT, KG 0,435

MANUFACTURER [ABC](#)

INTERCHANGE

SKF	81117
INA	81117 TN
IKO	AZ 8511019