

81118 INA

Cylindrical roller thrust bearings

TYPE: Roller bearings, Thrust roller bearing, Cylindrical, Single direction

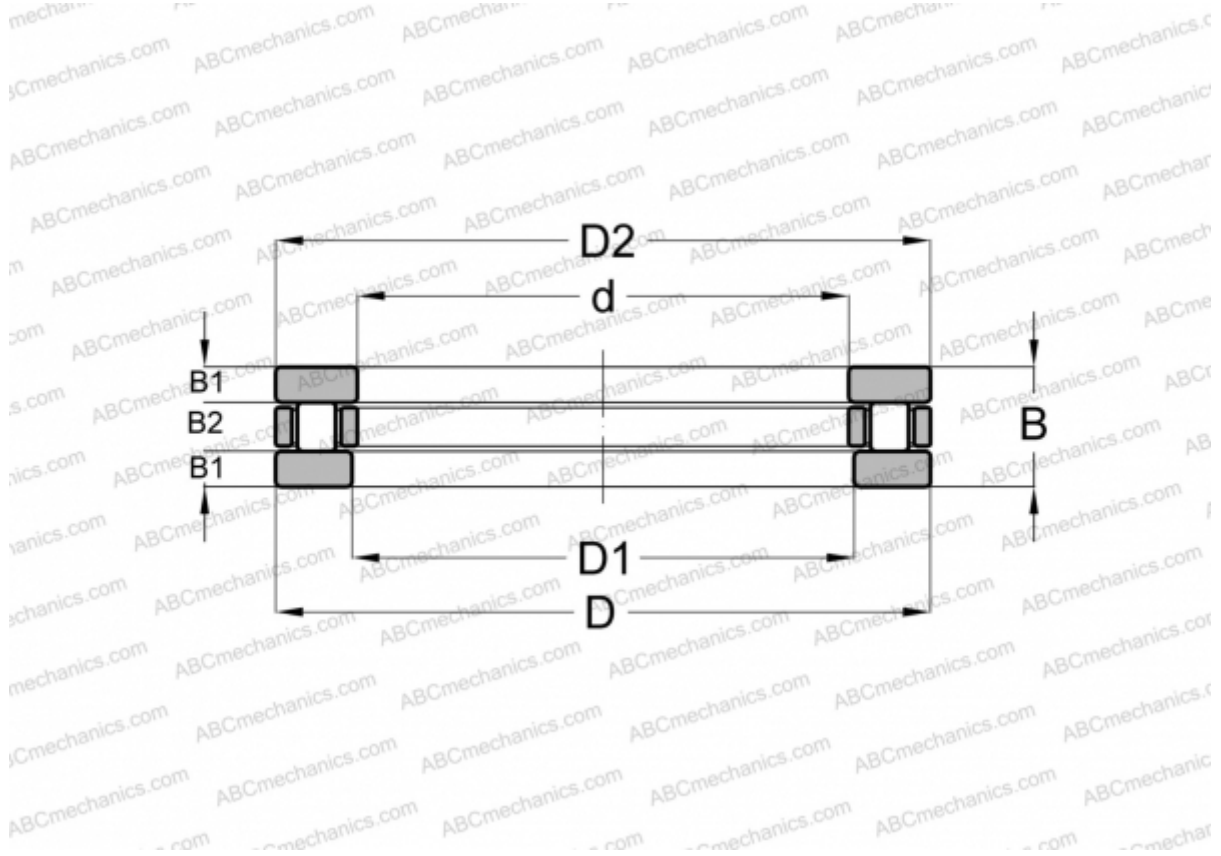

Technical specification

DIMENSIONS, MM

d	90,000
D	120,000
D1	92,000
D2	120,000
B	22,000
B1	6,500
B2	9,000

WEIGHT, KG 0,649

MANUFACTURER [INA](#)

INTERCHANGE

ABC	81118
SKF	81118
IKO	AZ 9012022