

81122 SKF

Cylindrical roller thrust bearings

TYPE: Roller bearings, Thrust roller bearing, Cylindrical, Single direction

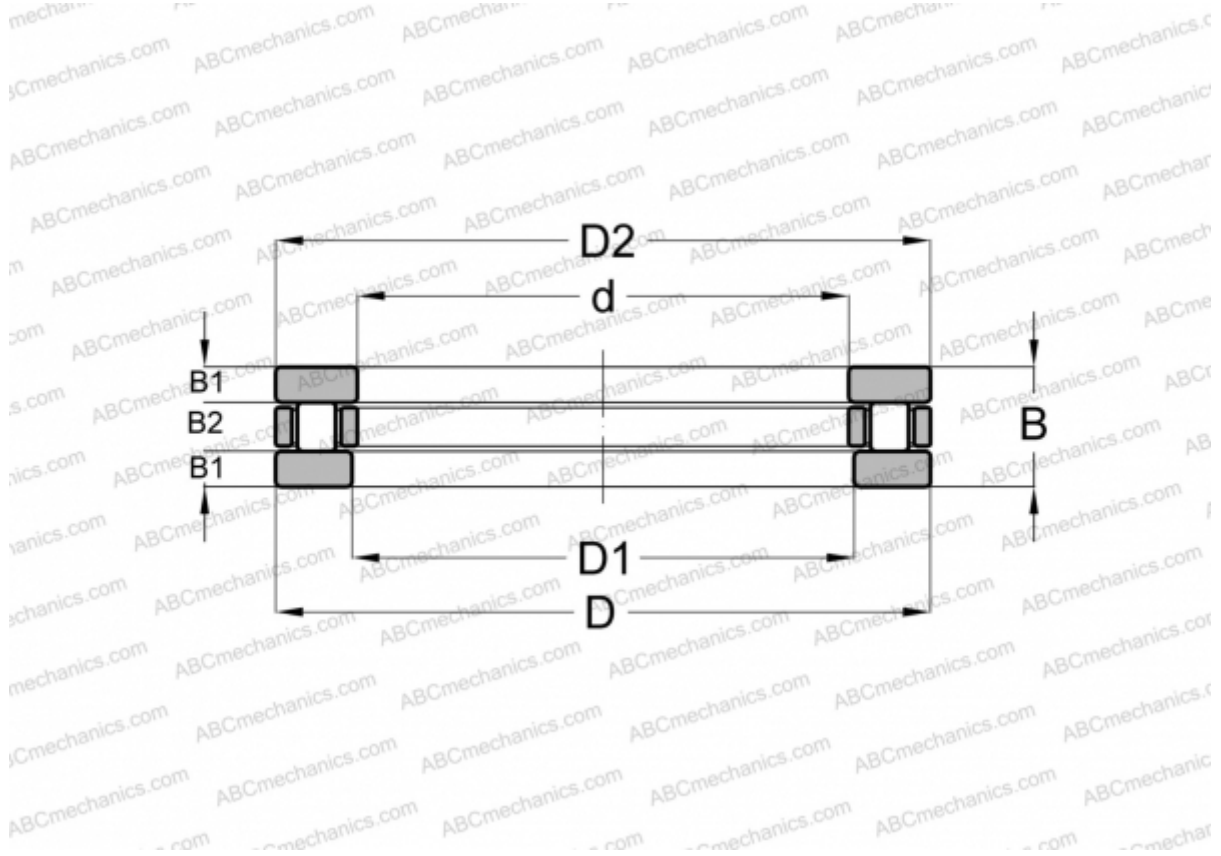

Technical specification

DIMENSIONS, MM

d	110,000
D	145,000
D1	112,000
D2	145,000
B	25,000
B1	7,000
B2	11,000

WEIGHT, KG 1,021

MANUFACTURER [SKF](#)

INTERCHANGE

ABC	81122
INA	81122
IKO	AZ 11014525