

81128 ABC

Cylindrical roller thrust bearings

TYPE: Roller bearings, Thrust roller bearing, Cylindrical, Single direction

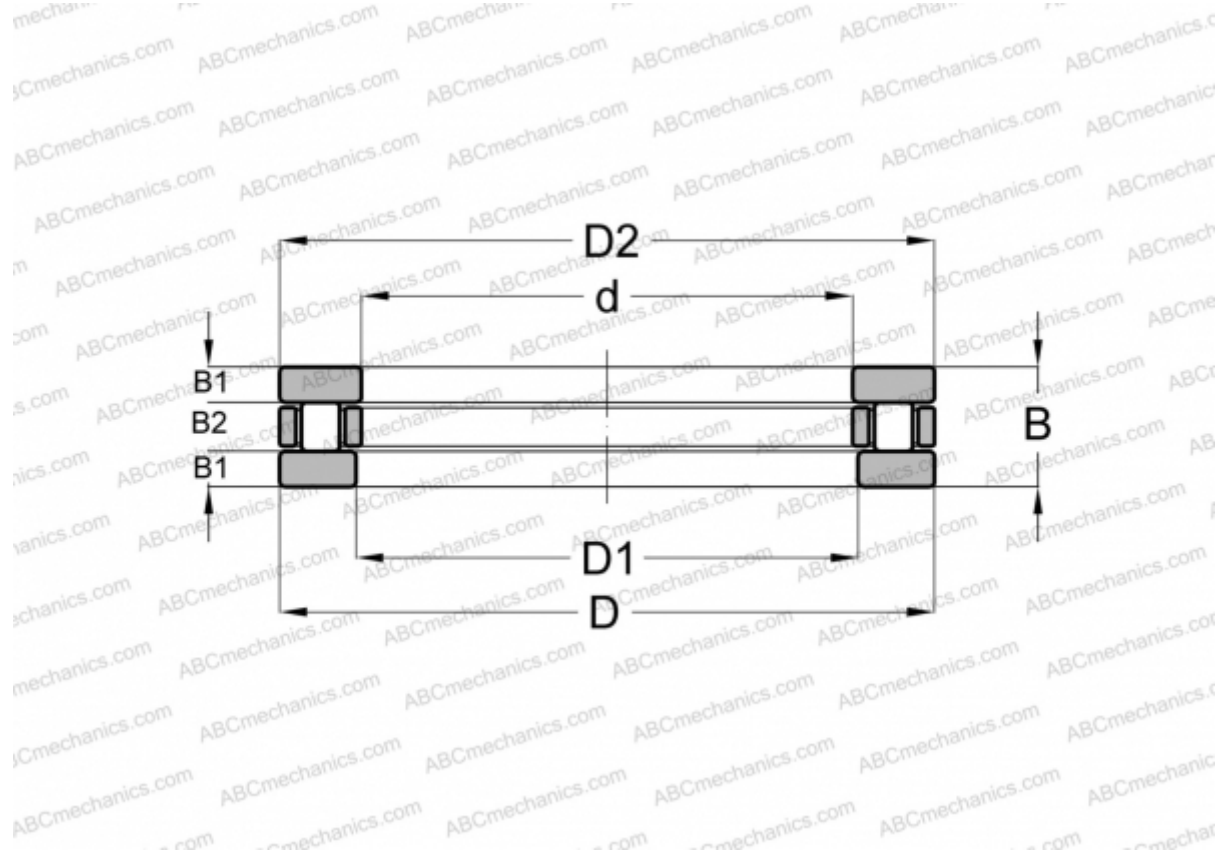

Technical specification

DIMENSIONS, MM

d	140,000
D	180,000
D1	142,000
D2	178,000
B	31,000
B1	9,500
B2	12,000

WEIGHT, KG 2,100

MANUFACTURER [ABC](#)

INTERCHANGE

SKF	81128
INA	81128
IKO	AZ 14018031