

## 81128 INA

Cylindrical roller thrust bearings

TYPE: Roller bearings, Thrust roller bearing, Cylindrical, Single direction

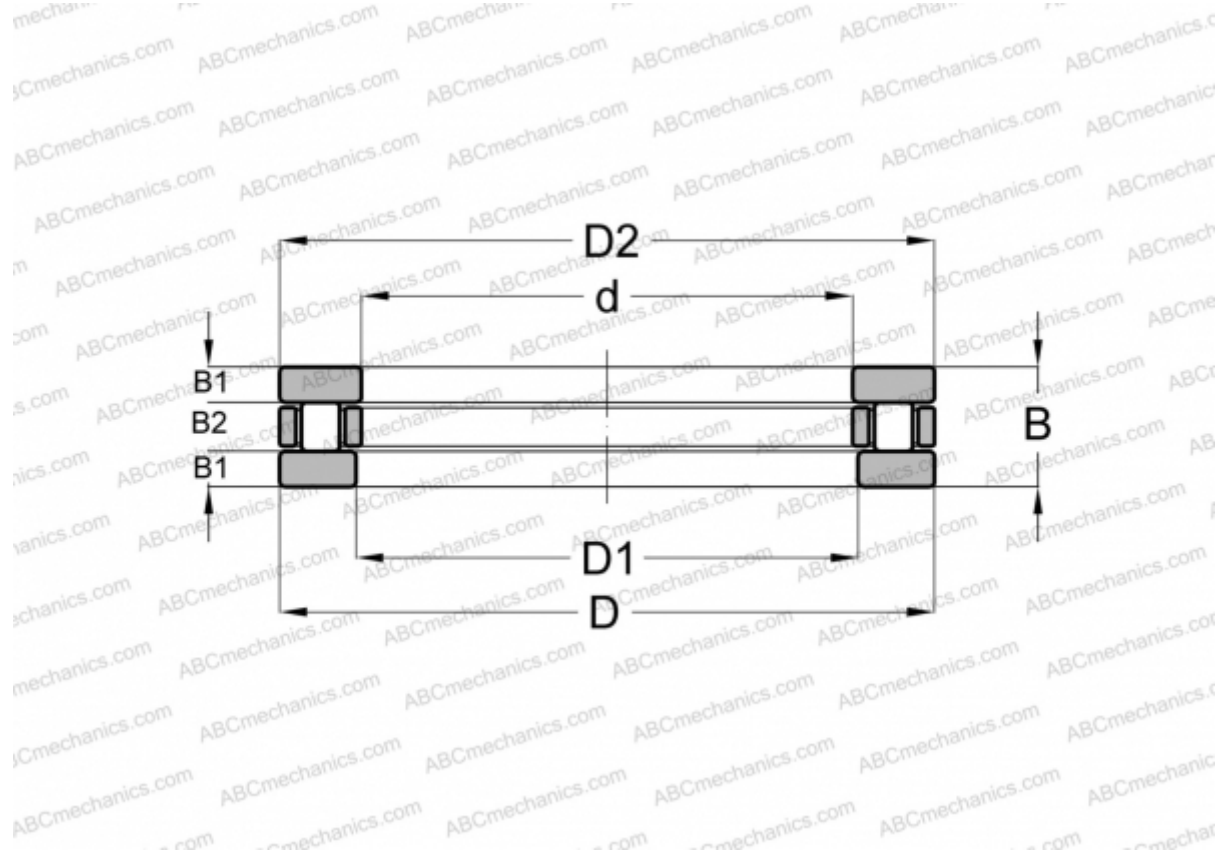

### Technical specification

#### DIMENSIONS, MM

d	140,000
D	180,000
D1	142,000
D2	178,000
B	31,000
B1	9,500
B2	12,000

**WEIGHT, KG** 2,100

**MANUFACTURER** [INA](#)

#### INTERCHANGE

ABC	<a href="#">81128</a>
SKF	<a href="#">81128</a>
IKO	<a href="#">AZ 14018031</a>