

AZ 9016026 IKO

Cylindrical roller thrust bearings

TYPE: Roller bearings, Thrust roller bearing, Cylindrical, Single direction

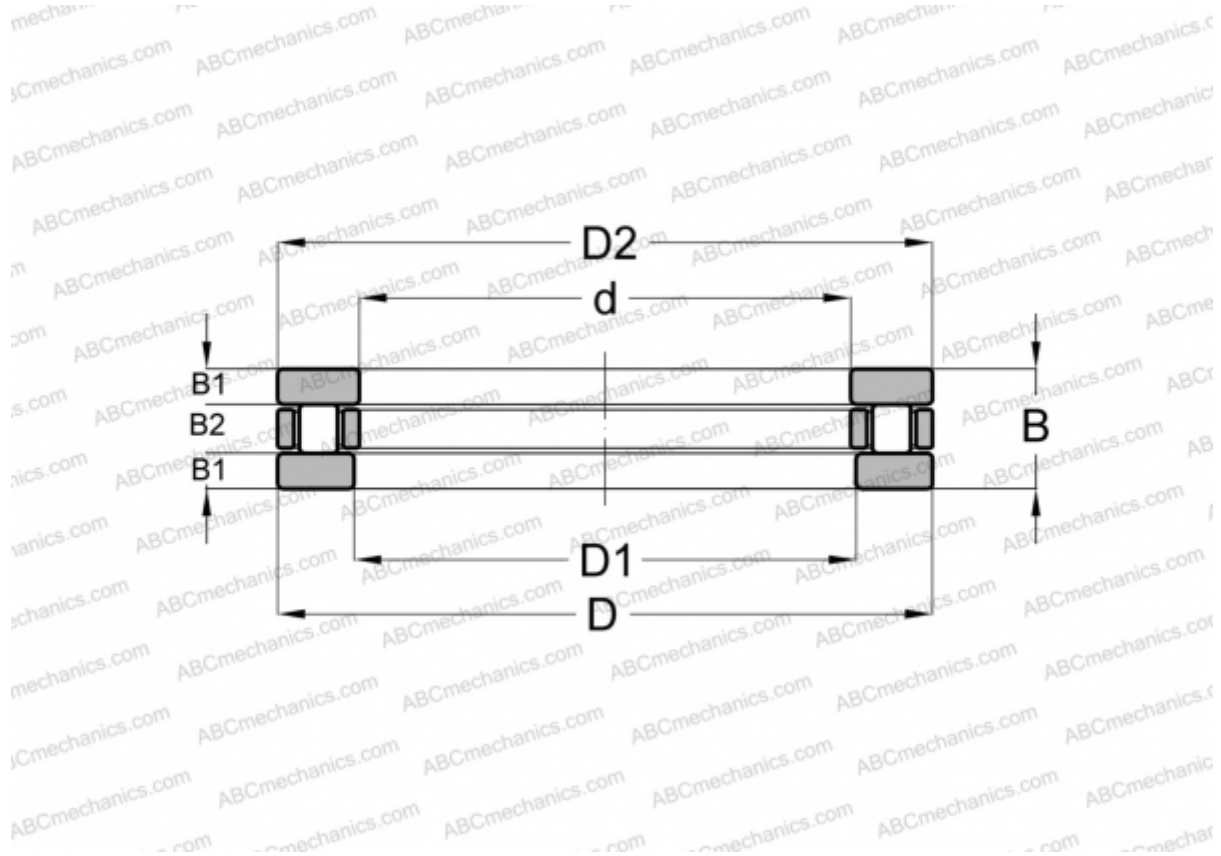

Technical specification

DIMENSIONS, MM

d	90,000
D	160,000
D1	90,050
B	26,000
B1	8,000
B2	10,000

WEIGHT, KG 2,710

MANUFACTURER [IKO](#)

CALCULATION DATA

Basic dynamic load rating, C	189,000 kN
Basic static load rating, Co	871,000 kN

INCLUDED PRODUCTS

AZK 9016010, GS 90160, WS 90160