

81111 TN SKF

Cylindrical roller thrust bearings

TYPE: Roller bearings, Thrust roller bearing, Cylindrical, Single direction

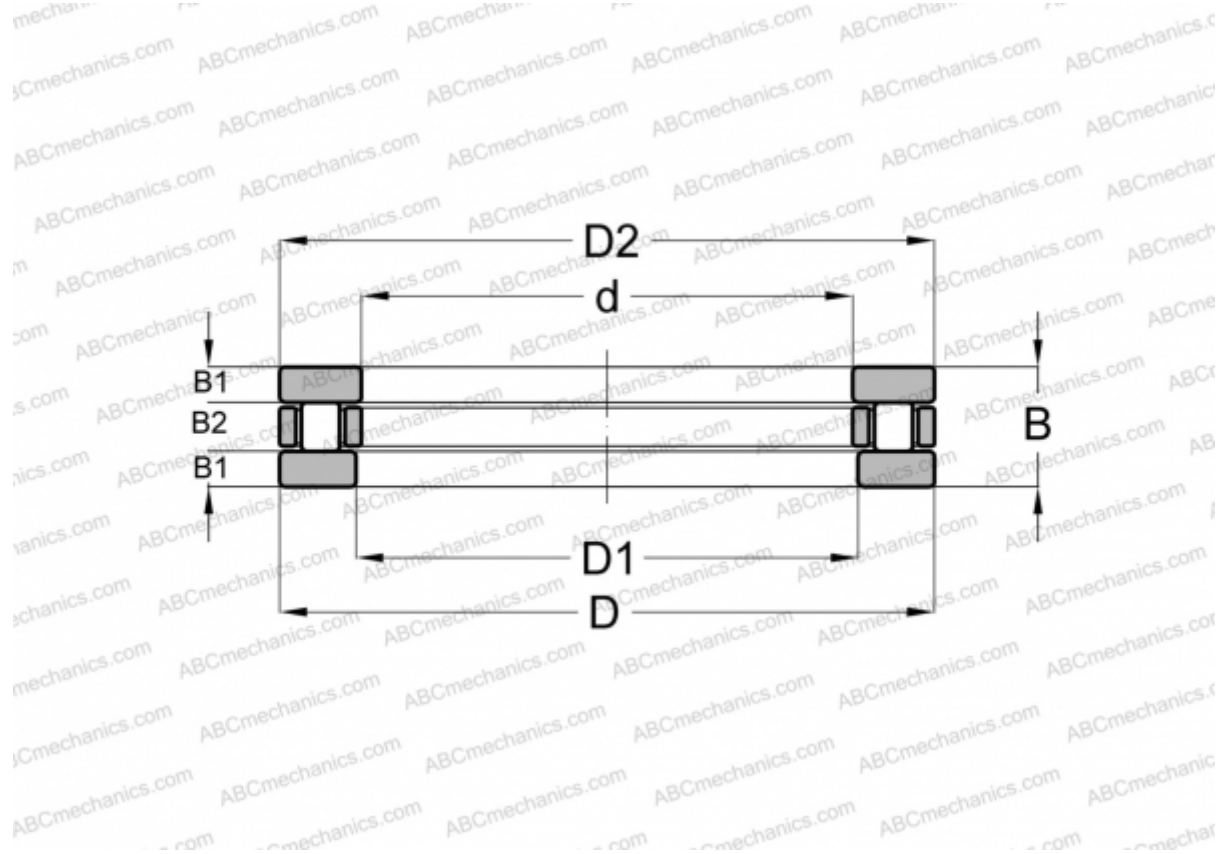

Technical specification

DIMENSIONS, MM

d	55,000
D	78,000
D1	57,000
D2	78,000
B	16,000
B1	5,000
B2	6,000

WEIGHT, KG 0,220

MANUFACTURER [SKF](#)

CALCULATION DATA

Basic dynamic load rating, C	69,500 kN
Basic static load rating, Co	285,000 kN
Fatigue load limit, Pu	29,000 kN

INCLUDED PRODUCTS

K 81111 TN, WS 81111, GS 81111

CALCULATION DATA

Reference speed	1900 r/min
Limiting speed	3800 r/min