

81213 TN SKF

Cylindrical roller thrust bearings

TYPE: Roller bearings, Thrust roller bearing, Cylindrical, Single direction

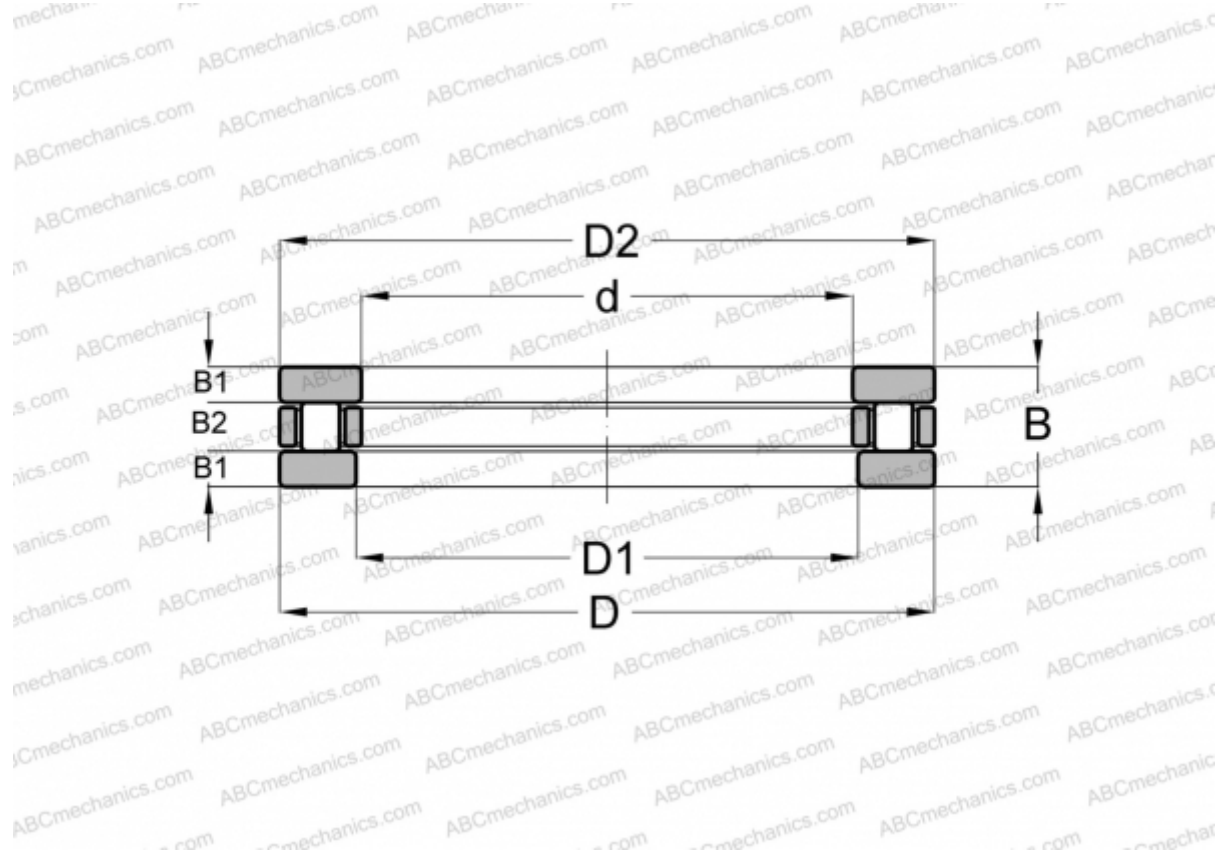

Technical specification

DIMENSIONS, MM

d	65,000
D	100,000
D1	67,000
D2	100,000
B	27,000
B1	8,000
B2	11,000

WEIGHT, KG 0,720

MANUFACTURER [SKF](#)

CALCULATION DATA

Basic dynamic load rating, C	140,000 kN
Basic static load rating, Co	490,000 kN
Fatigue load limit, Pu	50,000 kN

INCLUDED PRODUCTS

K 81213 TN, WS 81213, GS 81213

CALCULATION DATA

Reference speed	1300 r/min
Limiting speed	2600 r/min