

81214 TN SKF

Cylindrical roller thrust bearings

TYPE: Roller bearings, Thrust roller bearing, Cylindrical, Single direction

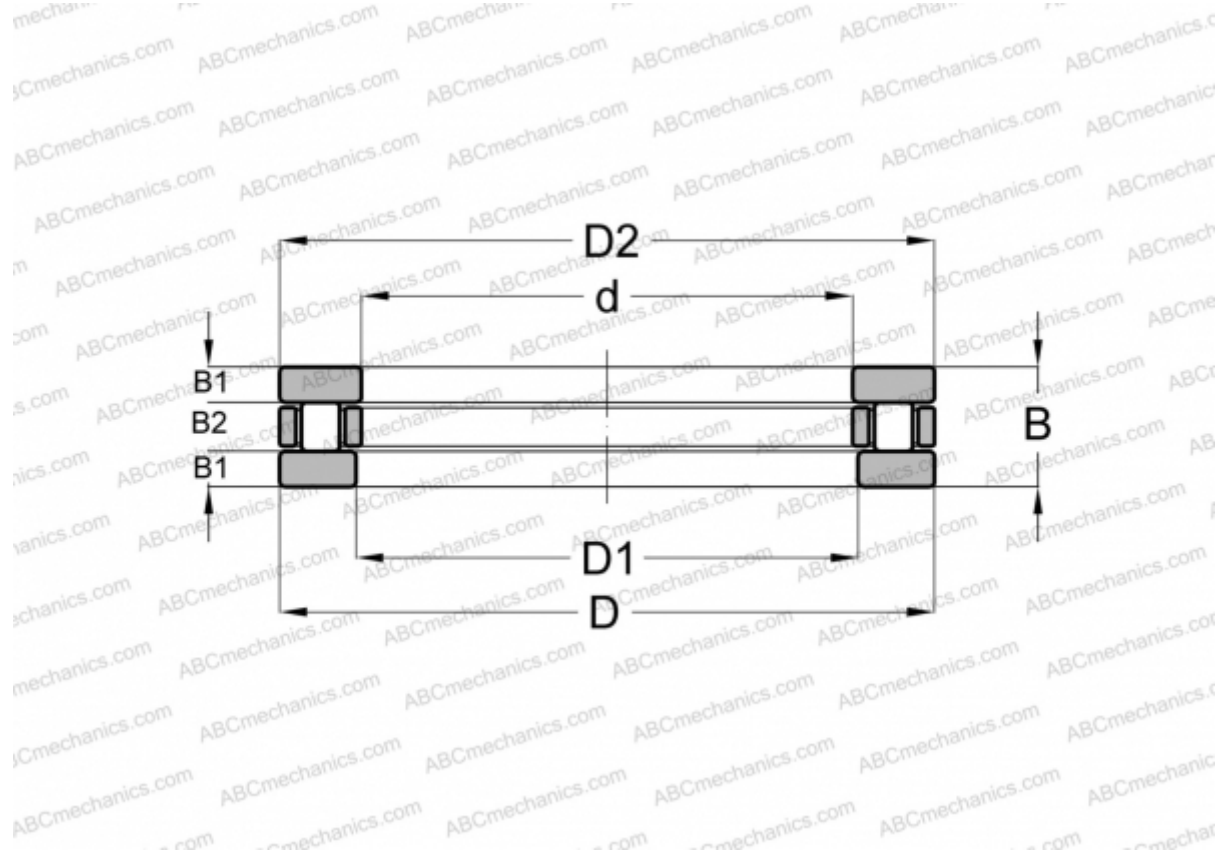

Technical specification

DIMENSIONS, MM

d	70,000
D	105,000
D1	72,000
D2	105,000
B	27,000
B1	8,000
B2	11,000

WEIGHT, KG 0,770

MANUFACTURER [SKF](#)

CALCULATION DATA

Basic dynamic load rating, C	146,000 kN
Basic static load rating, Co	530,000 kN
Fatigue load limit, Pu	55,000 kN

INCLUDED PRODUCTS

K 81214 TN, WS 81214, GS 81214

CALCULATION DATA

Reference speed	1300 r/min
Limiting speed	2600 r/min