

MCFR-40 McGill

Cam followers

TYPE: Roller bearings, Stud type track rollers, With axial guidance, gap seals on both side

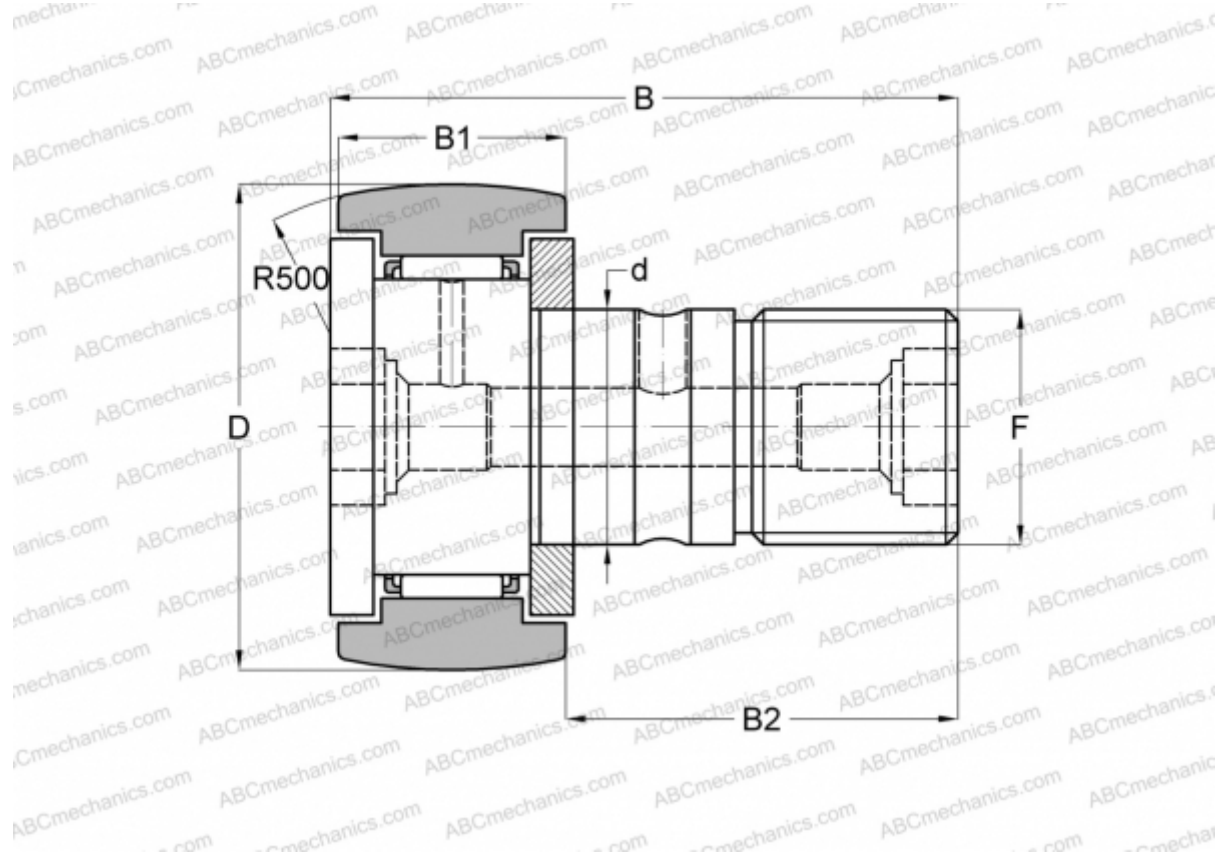

Technical specification

DIMENSIONS, MM

d	18,000
D	40,000
B	58,000
B1	20,000
B2	36,500
F	M18x1.5

WEIGHT, KG 0,255

MANUFACTURER [McGill](#)

INTERCHANGE

ABC	KR 40
INA	KR 40
SKF	KR 40 B
IKO	CF 18 R