

MCFR-80 McGill

Cam followers

TYPE: Roller bearings, Stud type track rollers, With axial guidance, gap seals on both side

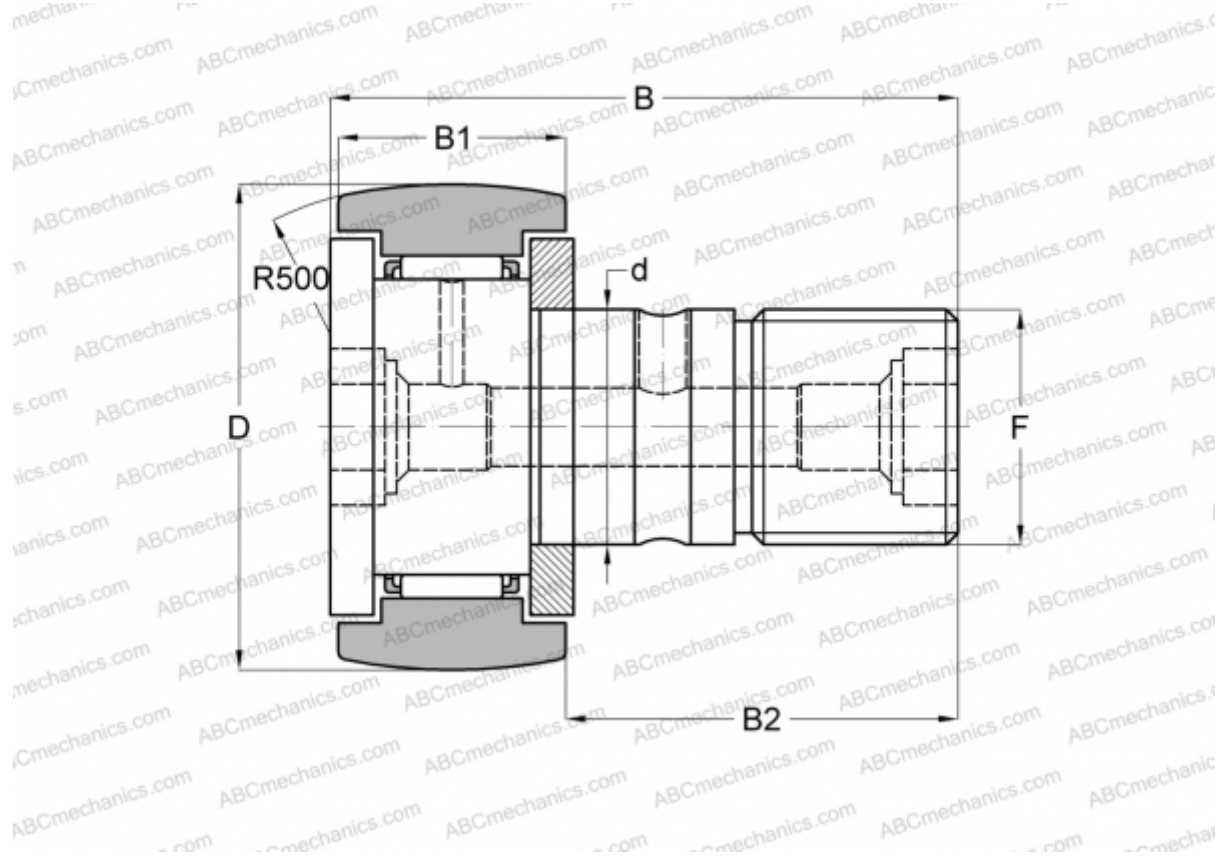

Technical specification

DIMENSIONS, MM

d	30,000
D	80,000
B	100,000
B1	35,000
B2	63,000
F	M30x1.5

WEIGHT, KG 1,665

MANUFACTURER [McGill](#)

INTERCHANGE

ABC	KR 80
INA	KR 80
SKF	KR 80
IKO	CF 30 R