

KR 19 DZ FAG

Cam followers

TYPE: Roller bearings, Stud type track rollers, With axial guidance, gap seals on both side, cylindrical outer ring

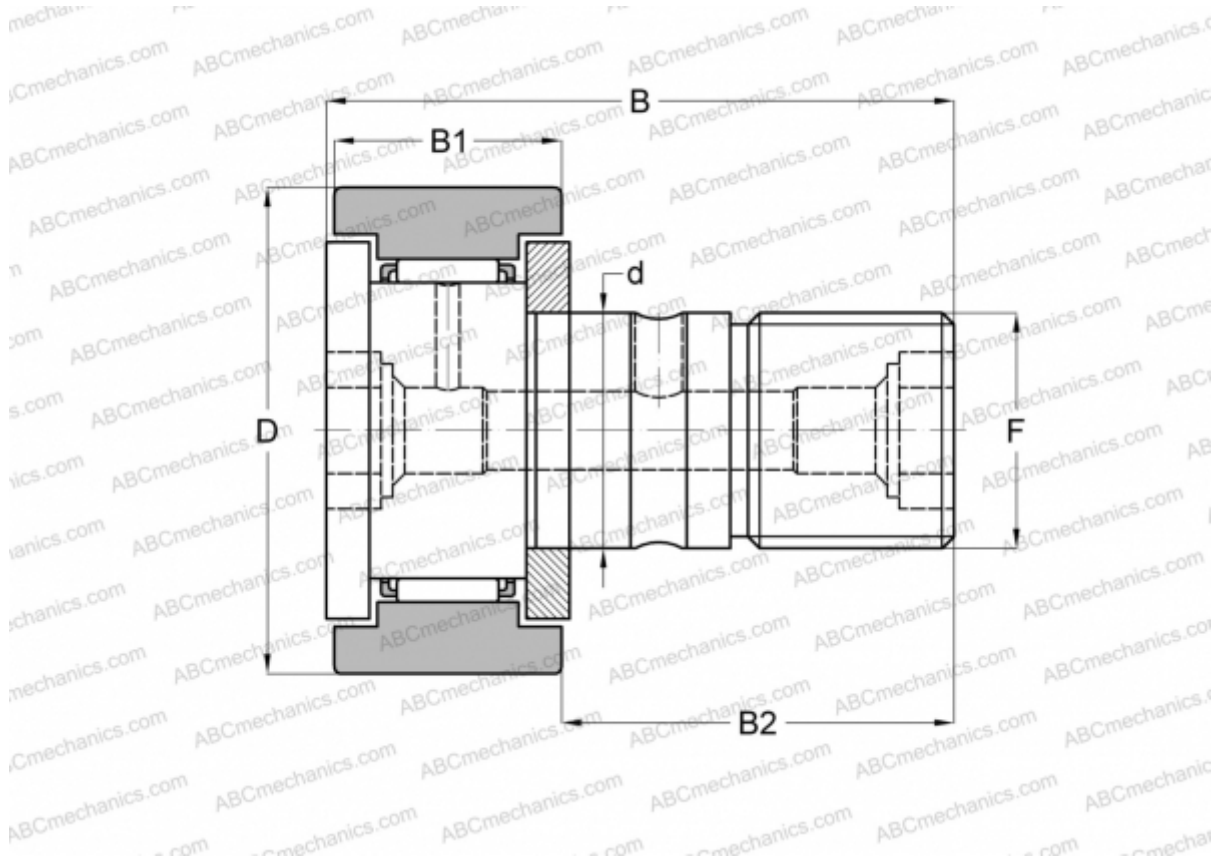

Technical specification

DIMENSIONS, MM

d	8,000
D	19,000
B	32,000
B1	11,000
B2	20,000
F	M8x1.25

WEIGHT, KG 0,032

MANUFACTURER [FAG](#)

INTERCHANGE

ABC	KR 19 X
INA	KR 19 X
SKF	KR 19 X
IKO	CF 8

INTERCHANGE

McGill [MCFR-19-X](#)