

KR 30 X ABC

Cam followers

TYPE: Roller bearings, Stud type track rollers, With axial guidance, gap seals on both side, cylindrical outer ring

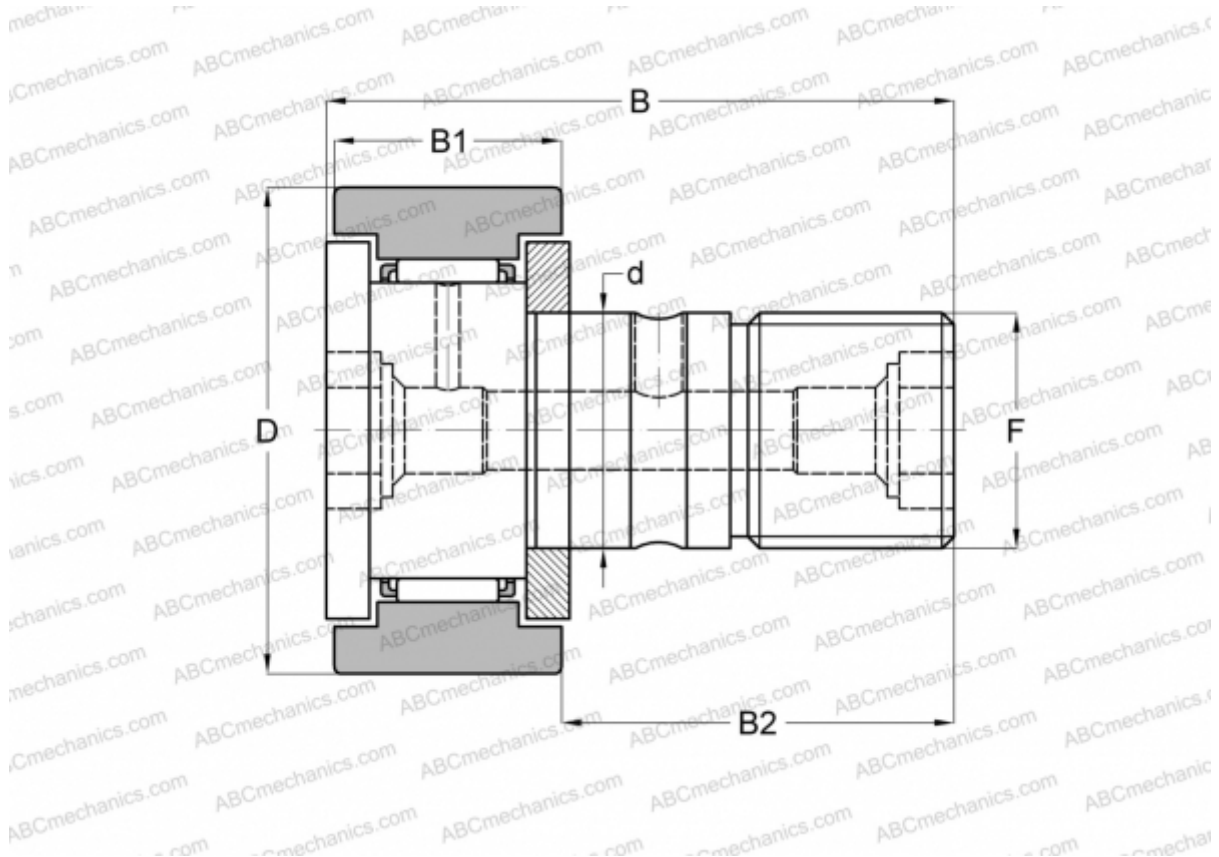

Technical specification

DIMENSIONS, MM

d	12,000
D	30,000
B	40,000
B1	14,000
B2	25,000
F	M12x1.5

WEIGHT, KG 0,091

MANUFACTURER [ABC](#)

INTERCHANGE

INA	KR 30 X
SKF	KR 30 X
IKO	CF 12
McGill	MCFR-30-X

INTERCHANGE

FAG [KR 30 DZ](#)