

## CF 18 IKO

Cam followers

TYPE: Roller bearings, Stud type track rollers, With axial guidance, gap seals on both side, cylindrical outer ring

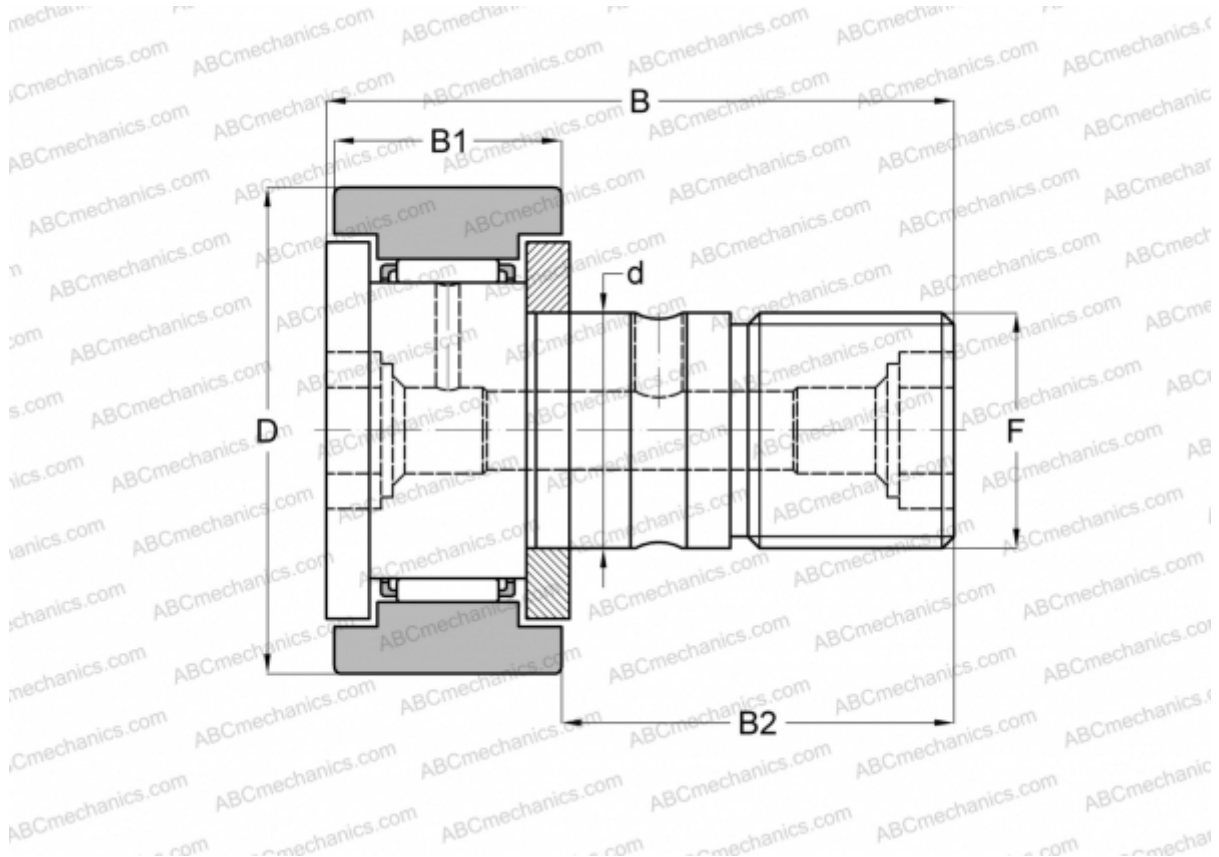

### Technical specification

#### DIMENSIONS, MM

d	18,000
D	40,000
B	58,100
B1	20,000
B2	36,500
F	M18x1.5

**WEIGHT, KG** 0,250

**MANUFACTURER** [IKO](#)

#### INTERCHANGE

ABC	<a href="#">KR 40 X</a>
INA	<a href="#">KR 40 X</a>
SKF	<a href="#">KR 40 X</a>
McGill	<a href="#">MCFR-40-X</a>

#### CALCULATION DATA

Basic dynamic load rating, C	14,800 kN
Basic static load rating, Co	25,200 kN