

## CFKR 30 IKO

Cam followers

TYPE: Roller bearings, Stud type track rollers, With axial guidance, gap seals on both side, double hex hole

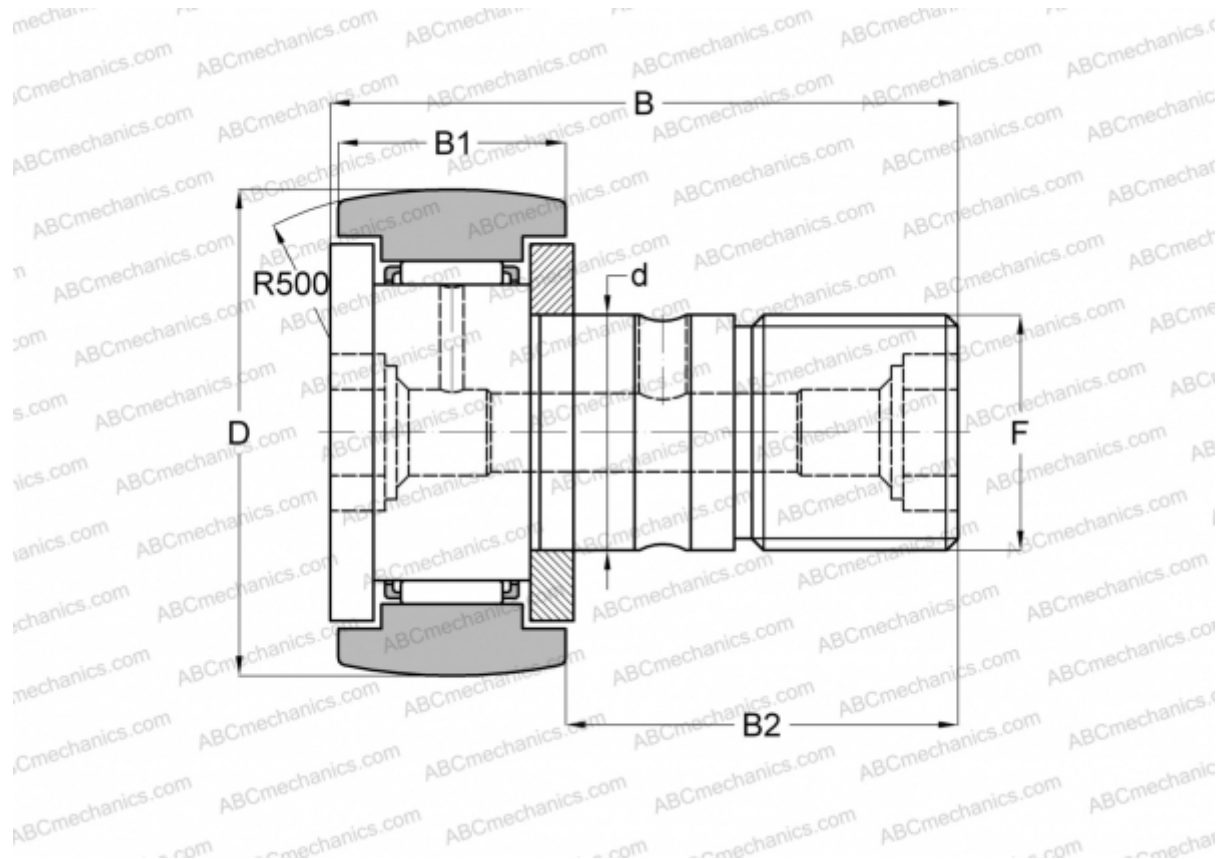

### Technical specification

#### DIMENSIONS, MM

d	12,000
D	30,000
B	40,200
B1	14,000
B2	25,000
F	M12x1.5

**WEIGHT, KG** 0,094

**MANUFACTURER** [IKO](#)

#### INTERCHANGE

ABC	<a href="#">CFKR 30</a>
JNS	<a href="#">CF 12 R-AB</a>
THK	<a href="#">CF 12 R-AB</a>

#### CALCULATION DATA

Basic dynamic load rating, C	7,910 kN
Basic static load rating, Co	9,790 kN