

CF 16 R-AB JNS

Cam followers

TYPE: Roller bearings, Stud type track rollers, With axial guidance, gap seals on both side, double hex hole

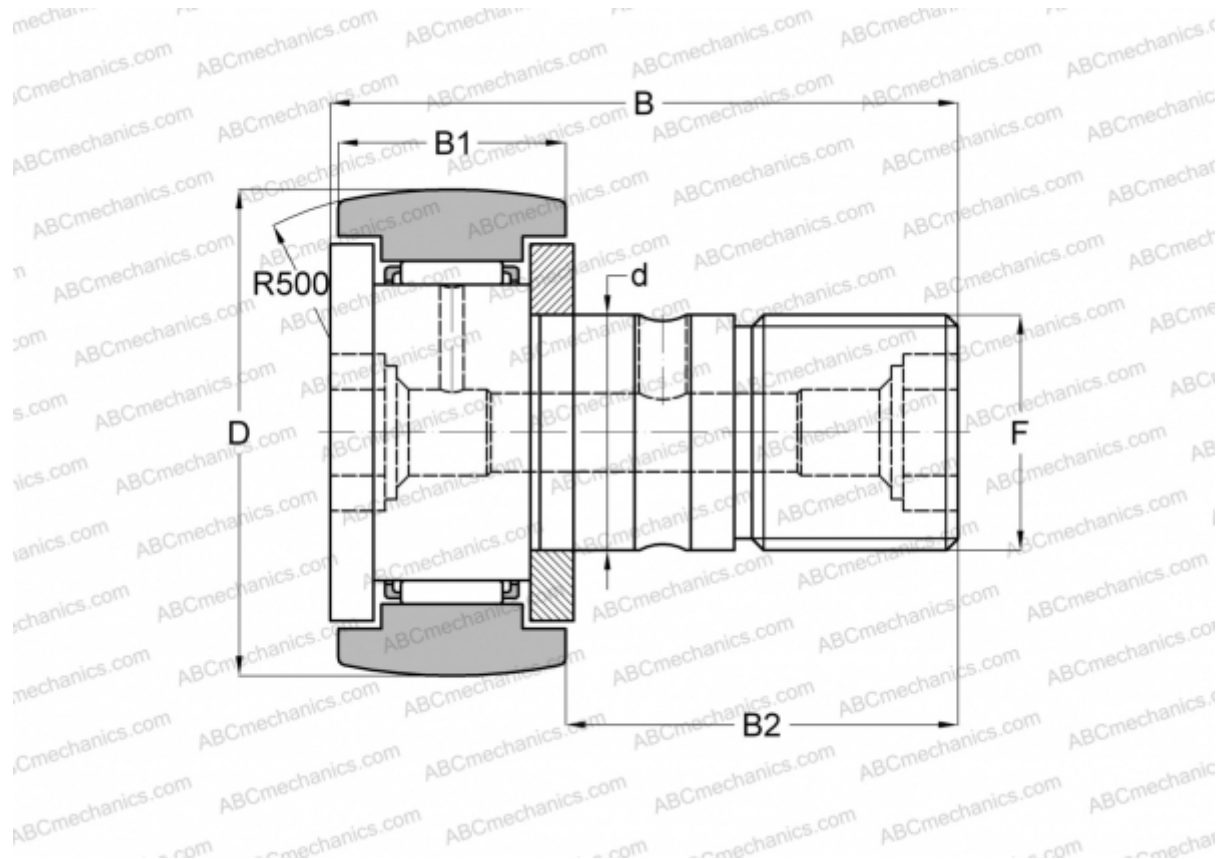

Technical specification

DIMENSIONS, MM

d	16,000
D	35,000
B	52,000
B1	18,000
B2	32,500
F	M16x1,5

WEIGHT, KG 0,177

MANUFACTURER [JNS](#)

INTERCHANGE

ABC	CFKR 35
IKO	CFKR 35
THK	CF 16 R-AB