

CFKR 26 R IKO

Cam followers

TYPE: Roller bearings, Stud type track rollers, With axial guidance, gap seals on both side, cylindrical outer ring, double hex hole

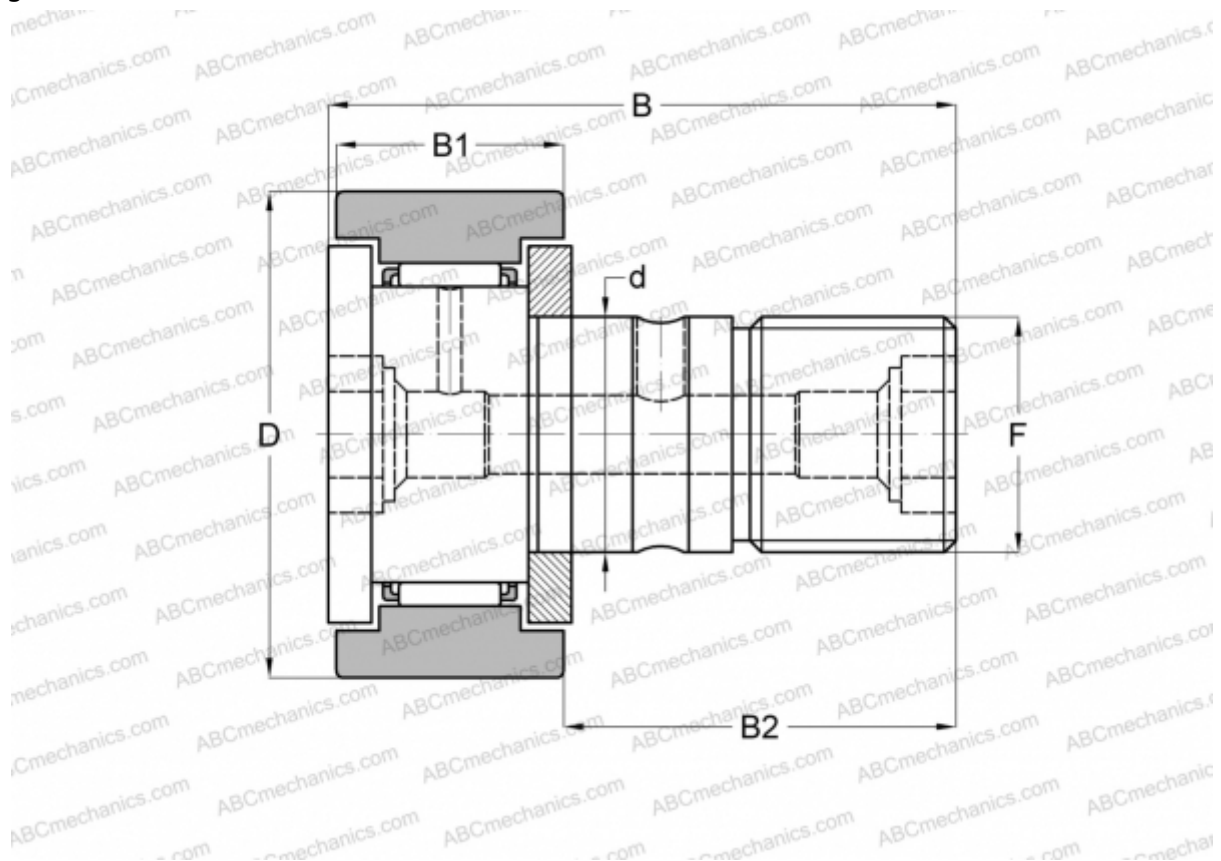

Technical specification

DIMENSIONS, MM

d	10,000
D	26,000
B	36,200
B1	12,000
B2	23,000
F	M10x1.0

WEIGHT, KG 0,058

MANUFACTURER [IKO](#)

INTERCHANGE

ABC [CFKR 26 R](#)

CALCULATION DATA

Basic dynamic load rating, C	5,430 kN
Basic static load rating, Co	6,890 kN