

## CF 12-AB THK

Cam followers

TYPE: Roller bearings, Stud type track rollers, With axial guidance, gap seals on both side, cylindrical outer ring, double hex hole

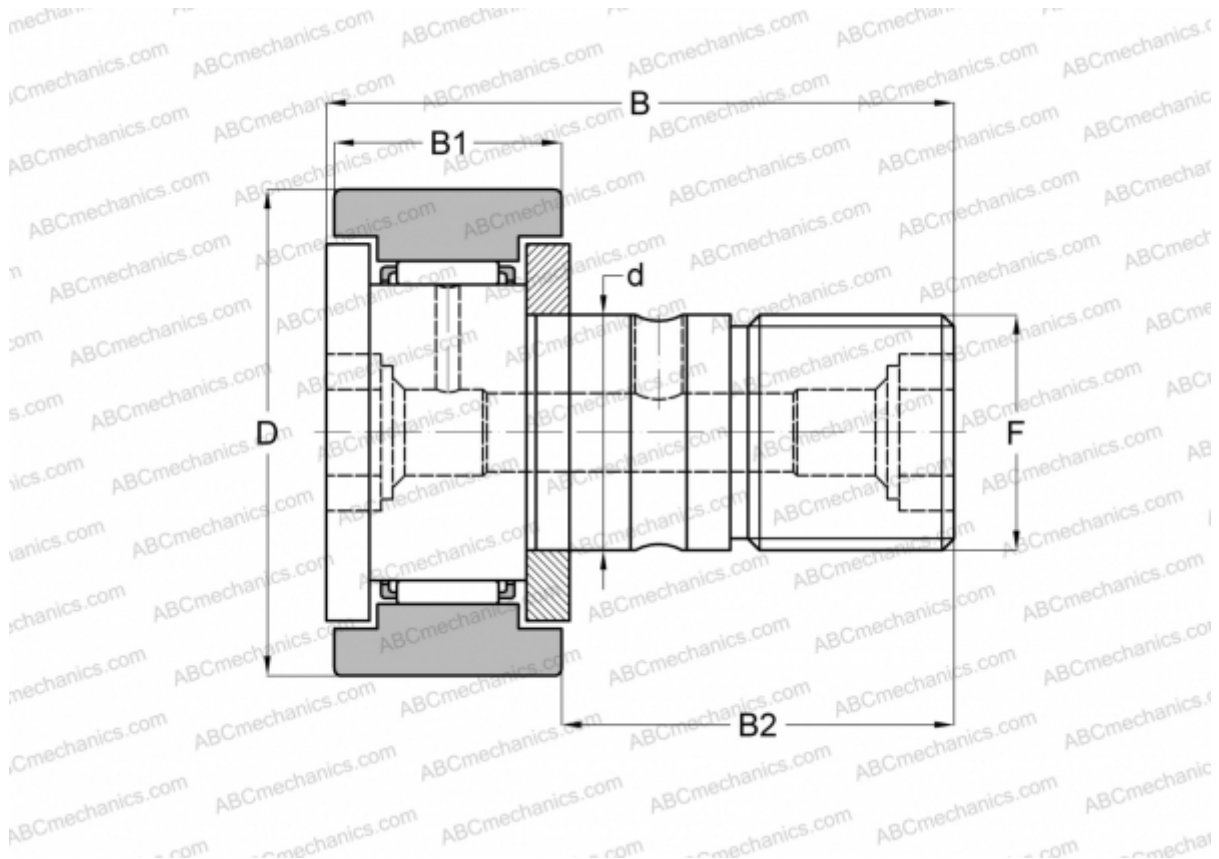

### Technical specification

#### DIMENSIONS, MM

d	12,000
D	30,000
B	40,000
B1	14,000
B2	25,000
F	M12x1.5

**WEIGHT, KG** 0,091

**MANUFACTURER** [THK](#)

#### INTERCHANGE

ABC	<a href="#">CFKR 30 R</a>
IKO	<a href="#">CFKR 30 R</a>
JNS	<a href="#">CF 12-AB</a>