

## CF 24-AB JNS

Cam followers

TYPE: Roller bearings, Stud type track rollers, With axial guidance, gap seals on both side, cylindrical outer ring, double hex hole

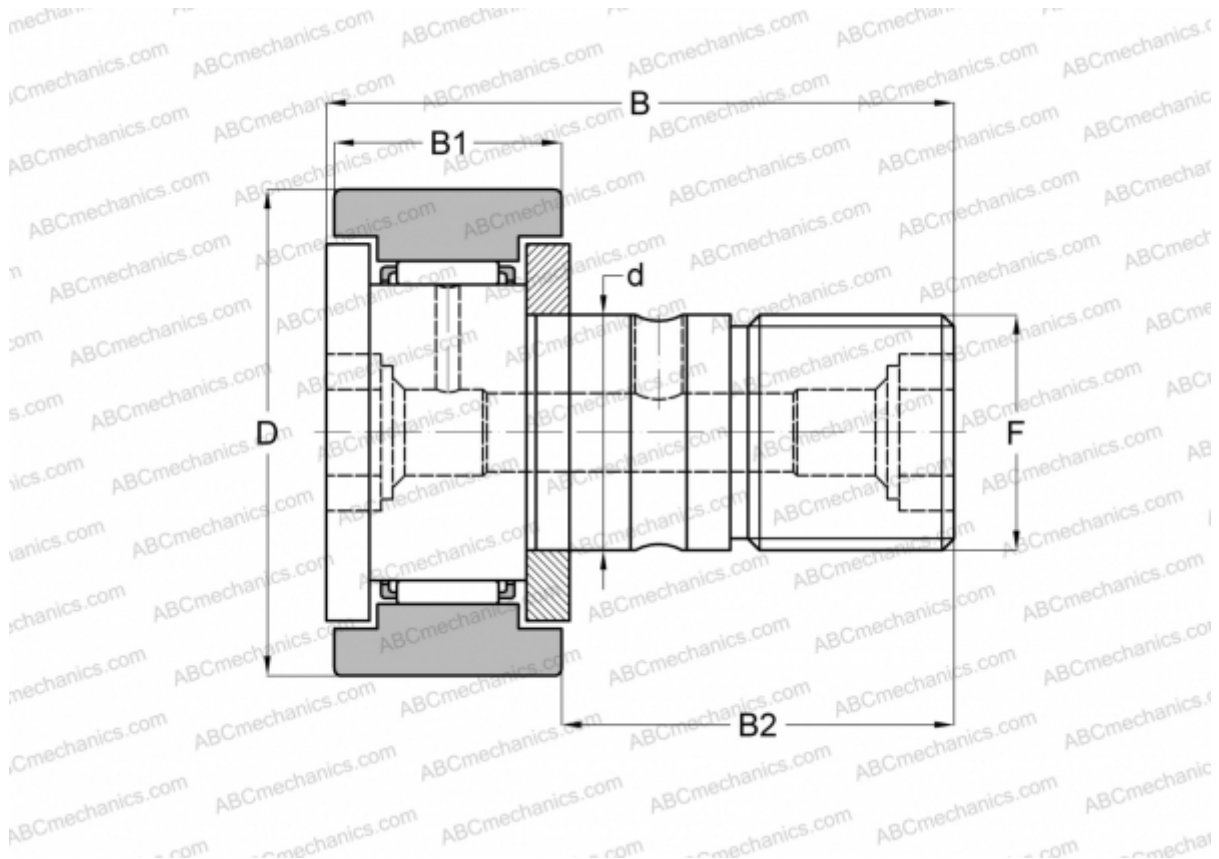

### Technical specification

#### DIMENSIONS, MM

d	24,000
D	62,000
B	80,000
B1	29,000
B2	49,500
F	M24x1.5

**WEIGHT, KG** 0,798

**MANUFACTURER** [JNS](#)

#### INTERCHANGE

ABC	<a href="#">CFKR 62 R</a>
IKO	<a href="#">CFKR 62 R</a>
THK	<a href="#">CF 24-AB</a>