

KR 19 PPA SKF

Cam followers

TYPE: Roller bearings, Stud type track rollers, With axial guidance, sealing rings on both sides

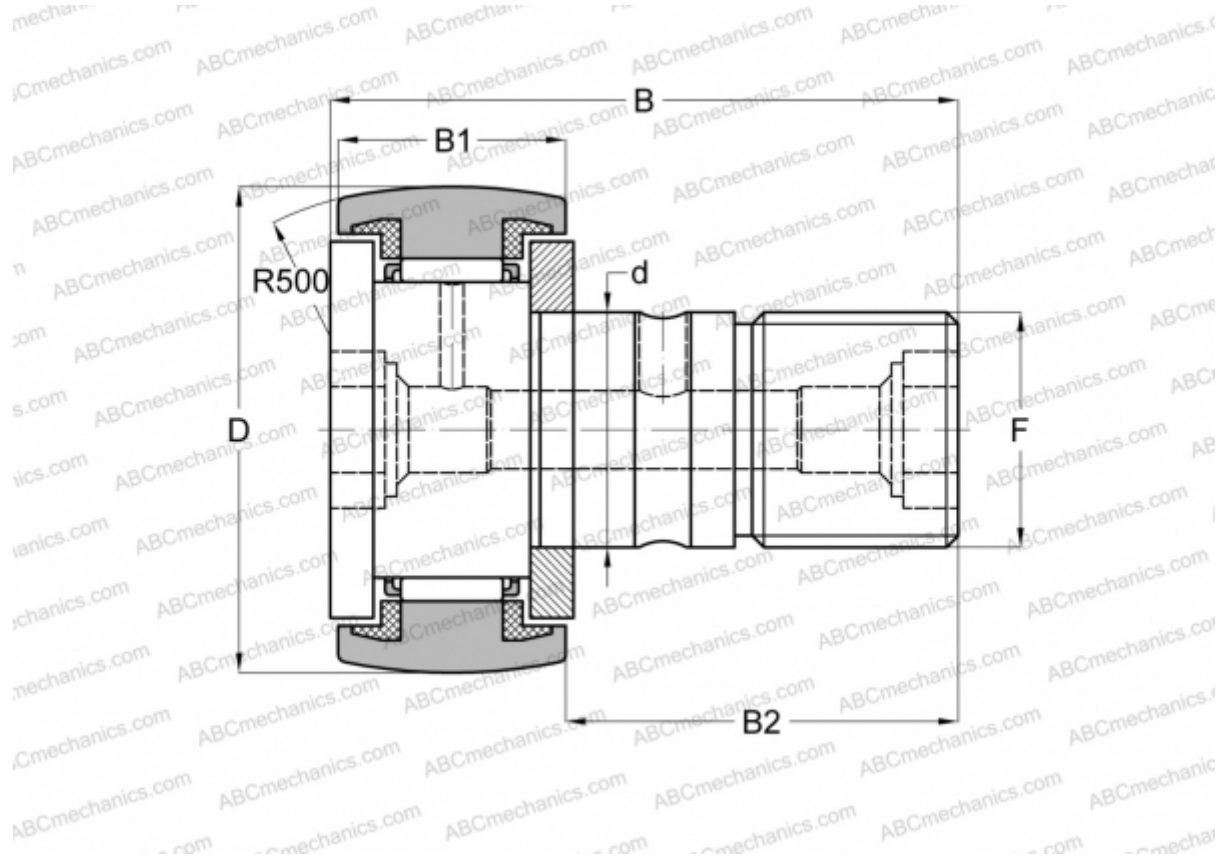

Technical specification

DIMENSIONS, MM

d	8,000
D	19,000
B	32,000
B1	11,000
B2	20,000
F	M8

WEIGHT, KG 0,029

MANUFACTURER [SKF](#)

INTERCHANGE

ABC	KR 19 PP
FAG	KR 19 C2RS/ NAKD 19
INA	KR 19 PP
IKO	CF 8 UUR

INTERCHANGE

McGill [MCFR-19-S](#)

CALCULATION DATA

Basic dynamic load rating, C	3,470 kN
Basic static load rating, Co	3,800 kN
Fatigue load limit, Pu	0,415 kN
Limiting speed	5600 r/min