

KR 35 PP INA

Cam followers

TYPE: Roller bearings, Stud type track rollers, With axial guidance, sealing rings on both sides

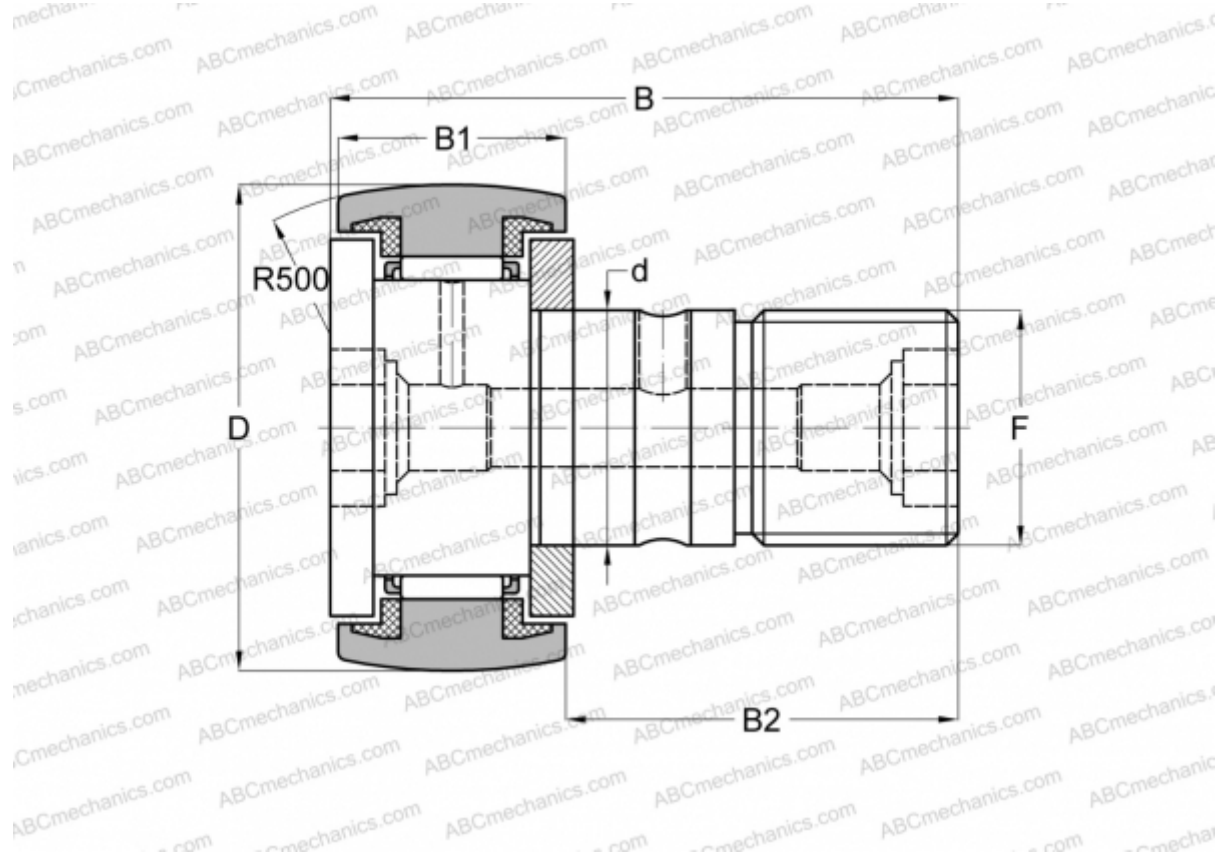

Technical specification

DIMENSIONS, MM

d	16,000
D	35,000
B	52,000
B1	18,000
B2	32,500
F	M16x1.5

WEIGHT, KG 0,177

MANUFACTURER [INA](#)

INTERCHANGE

ABC	KR 35 PP
SKF	KR 35 PPA
IKO	CF 16 UUR
McGill	MCFR-35-S