

CF 16 UUR IKO

Cam followers

TYPE: Roller bearings, Stud type track rollers, With axial guidance, sealing rings on both sides

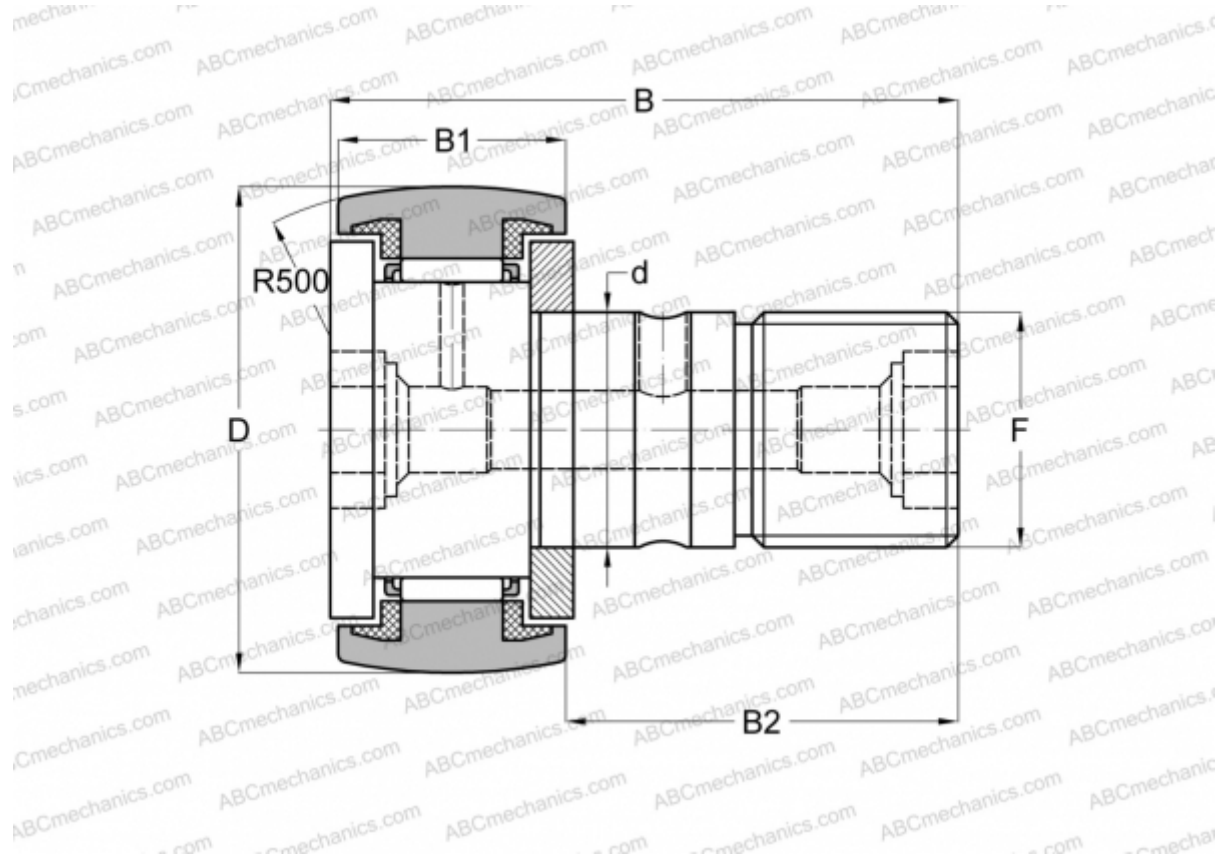

Technical specification

DIMENSIONS, MM

d	16,000
D	35,000
B	52,100
B1	18,000
B2	32,500
F	M16x1.5

WEIGHT, KG 0,170

MANUFACTURER [IKO](#)

INTERCHANGE

ABC	KR 35 PP
INA	KR 35 PP
SKF	KR 35 PPA
McGill	MCFR-35-S

CALCULATION DATA

Basic dynamic load rating, C	12,000 kN
Basic static load rating, Co	18,300 kN