

CF 20-1 UUR IKO

Cam followers

TYPE: Roller bearings, Stud type track rollers, With axial guidance, sealing rings on both sides

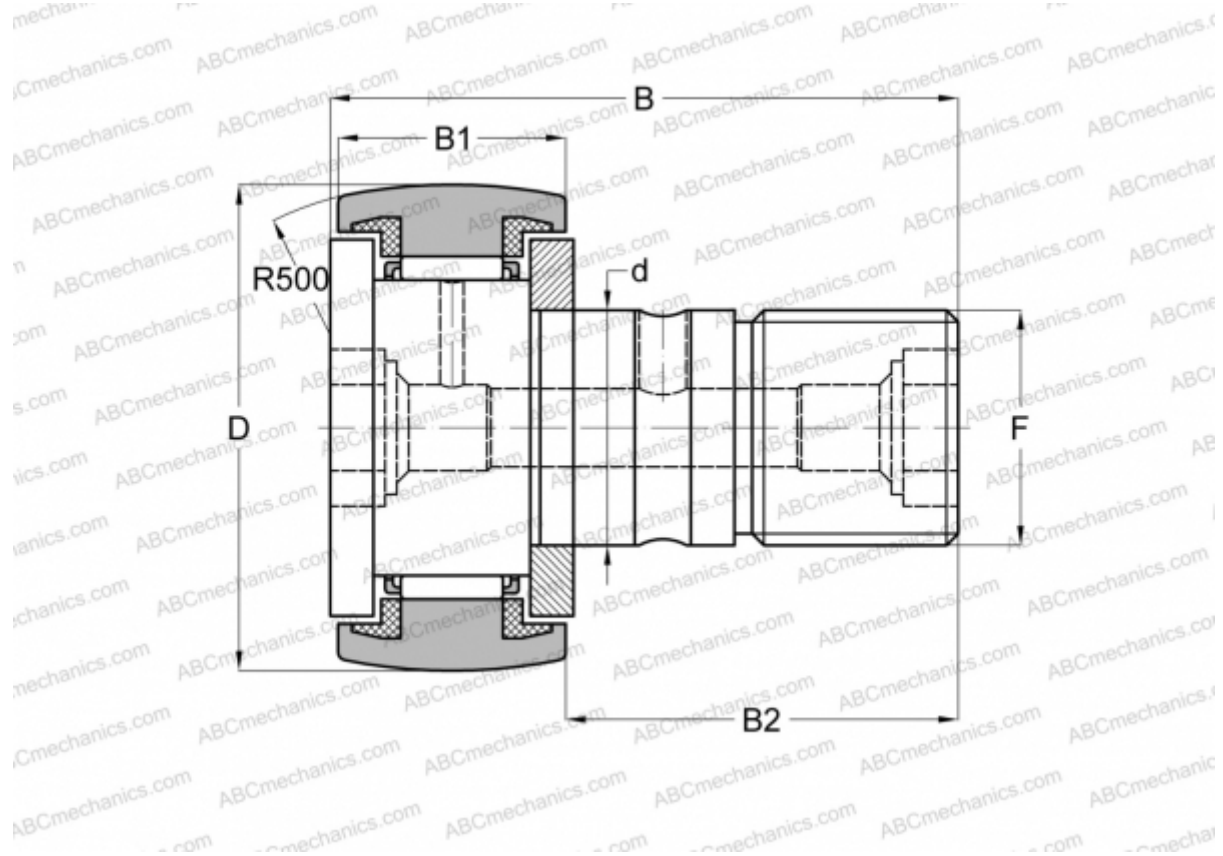

Technical specification

DIMENSIONS, MM

d	20,000
D	47,000
B	66,100
B1	24,000
B2	40,500
F	M20x1.5

WEIGHT, KG 0,385

MANUFACTURER [IKO](#)

INTERCHANGE

ABC	KR 47 PP
INA	KR 47 PP
SKF	KR 47 PPA
McGill	MCFR-47-S

CALCULATION DATA

Basic dynamic load rating, C	20,700 kN
Basic static load rating, Co	34,600 kN