

## KR 52 PP ABC

Cam followers

TYPE: Roller bearings, Stud type track rollers, With axial guidance, sealing rings on both sides

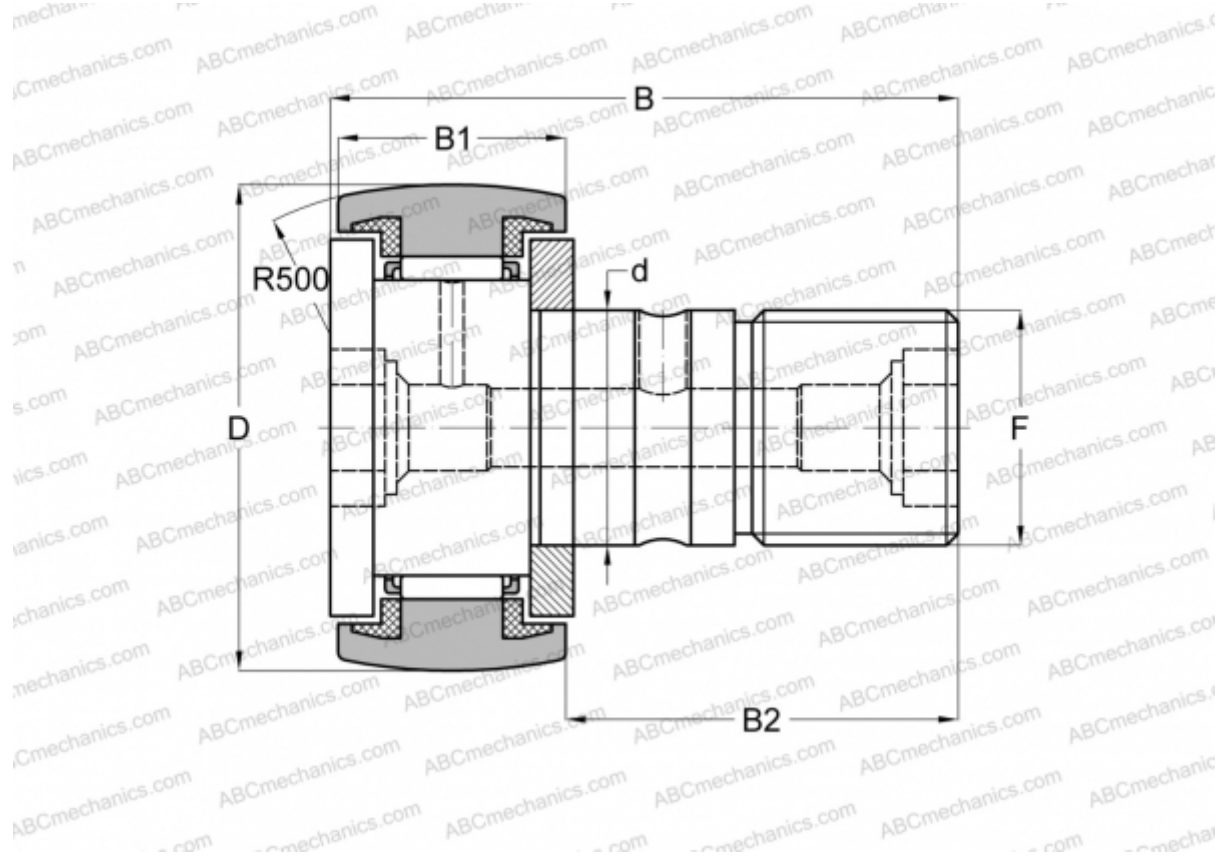

### Technical specification

#### DIMENSIONS, MM

d	20,000
D	52,000
B	66,000
B1	24,000
B2	40,500
F	M20x1.5

**WEIGHT, KG** 0,473

**MANUFACTURER** [ABC](#)

#### INTERCHANGE

INA	<a href="#">KR 52 PP</a>
SKF	<a href="#">KR 52 PPA</a>
IKO	<a href="#">CF 20 UUR</a>
McGill	<a href="#">MCFR-52-S</a>